

Operator's Manual
Lycoming

O-540, IO-540 Series

Approved by FAA

4th Edition

Part No. 60297-10

LYCOMING

June 2006

652 Oliver Street
Williamsport, PA. 17701 U.S.A.
570/323-6181

O-540, IO-540 Series Operator's Manual

Lycoming Part Number: 60297-10

©2006 by Lycoming. All rights reserved.

Lycoming and "Powered by Lycoming" are trademarks or registered trademarks of Lycoming.

All brand and product names referenced in this publication are trademarks or registered trademarks of their respective companies.

For additional information:

Mailing address:

Lycoming Engines
652 Oliver Street
Williamsport, PA 17701 U.S.A.

Phone:

Factory: 570-323-6181
Sales Department: 570-327-7268
Fax: 570-327-7101

Lycoming's regular business hours are Monday through Friday from 8:00 AM through 5:00 PM Eastern Time (+5 GMT)

Visit us on the World Wide Web at:

<http://www.lycoming.com>



**OPERATOR'S MANUAL
REVISION**

REVISION NO.	PUBLICATION	PUBLICATION NO.	PUBLICATION DATE
60297-10-3	O-540, IO-540 Series	60297-10	June 2006
The page(s) in this revision replace, add to, or delete current pages in the operator's manual.			
PREVIOUS REVISION		CURRENT REVISION	
August 2006 3-4 September 2008 3-7, 3-8; Added page 3-8A/B		March 2009 5-7	

LYCOMING OPERATOR'S MANUAL

ATTENTION

OWNERS, OPERATORS, AND MAINTENANCE PERSONNEL

This operator's manual contains a description of the engine, its specifications, and detailed information on how to operate and maintain it. Such maintenance procedures that may be required in conjunction with periodic inspections are also included. This manual is intended for use by owners, pilots and maintenance personnel responsible for care of Lycoming powered aircraft. Modifications and repair procedures are contained in Lycoming overhaul manuals; maintenance personnel should refer to these for such procedures.

SAFETY WARNING

Neglecting to follow the operating instructions and to carry out periodic maintenance procedures can result in poor engine performance and power loss. Also, if power and speed limitations specified in this manual are exceeded, for any reason, damage to the engine and personal injury can happen. Consult your local FAA approved maintenance facility.

SERVICE BULLETINS, INSTRUCTIONS, AND LETTERS

Although the information contained in this manual is up-to-date at time of publication, users are urged to keep abreast of later information through Lycoming Service Bulletins, Instructions and Service Letters which are available from all Lycoming distributors or from the factory by subscription. Consult the latest revision of Service Letter No. L114 for subscription information.

NOTE

The illustrations, pictures and drawings shown in this publication are typical of the subject matter they portray; in no instance are they to be interpreted as examples of any specific engine, equipment or part thereof.

LYCOMING OPERATOR'S MANUAL

IMPORTANT SAFETY NOTICE

Proper service and repair is essential to increase the safe, reliable operation of all aircraft engines. The service procedures recommended by Lycoming are effective methods for performing service operations. Some of these operations require the use of tools specially designed for the task. These special tools must be used when and as recommended.

It is important to note that most Lycoming publications contain various Warnings and Cautions which must be carefully read in order to minimize the risk of personal injury or the use of improper service methods that may damage the engine or render it unsafe.

It is also important to understand that these Warnings and Cautions are not all inclusive. Lycoming could not possibly know, evaluate or advise the service trade of all conceivable ways in which service might be done or of the possible hazardous consequences that may be involved. Accordingly, anyone who uses a service procedure must first satisfy themselves thoroughly that neither their safety nor aircraft safety will be jeopardized by the service procedure they select.

LYCOMING OPERATOR'S MANUAL

TABLE OF CONTENTS

		Page
SECTION 1	DESCRIPTION	1-1
SECTION 2	SPECIFICATIONS	2-1
SECTION 3	OPERATING INSTRUCTIONS	3-1
SECTION 4	PERIODIC INSPECTIONS	4-1
SECTION 5	MAINTENANCE PROCEDURES	5-1
SECTION 6	TROUBLE-SHOOTING	6-1
SECTION 7	INSTALLATION AND STORAGE	7-1
SECTION 8	TABLES	8-1

LYCOMING OPERATOR'S MANUAL

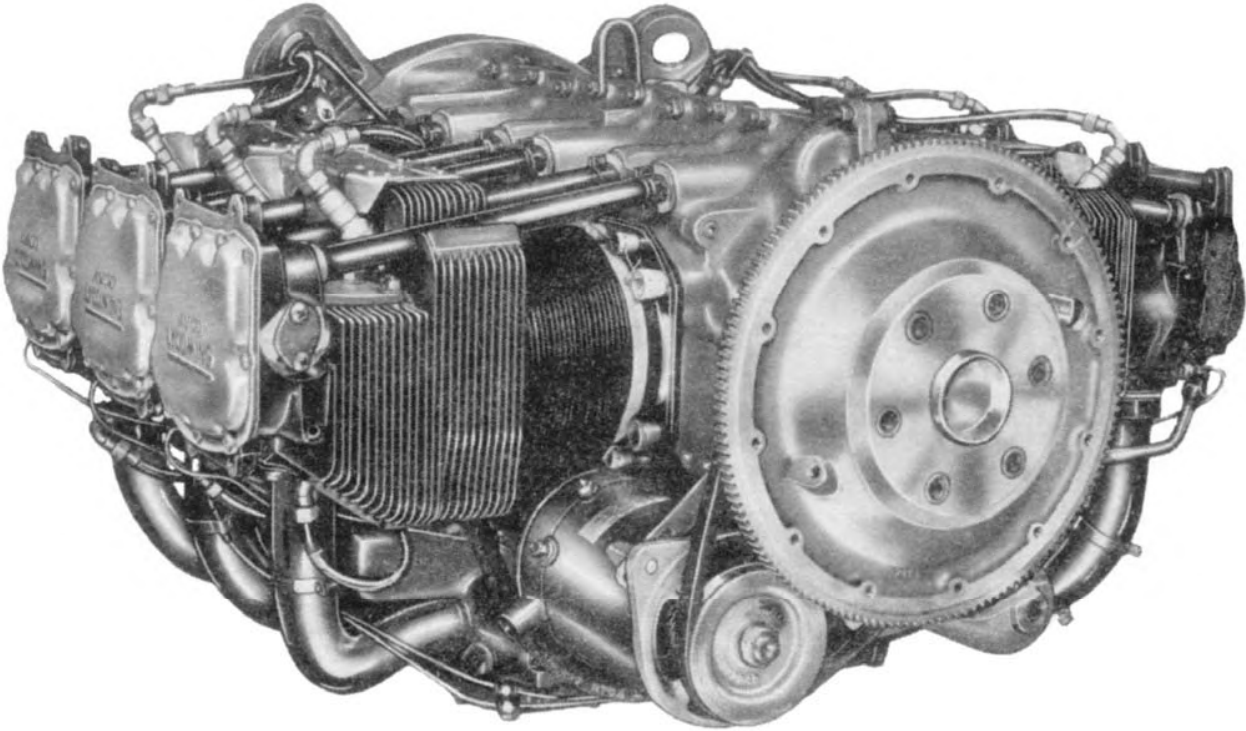

3/4 Right Front View – Typical IO-540-B

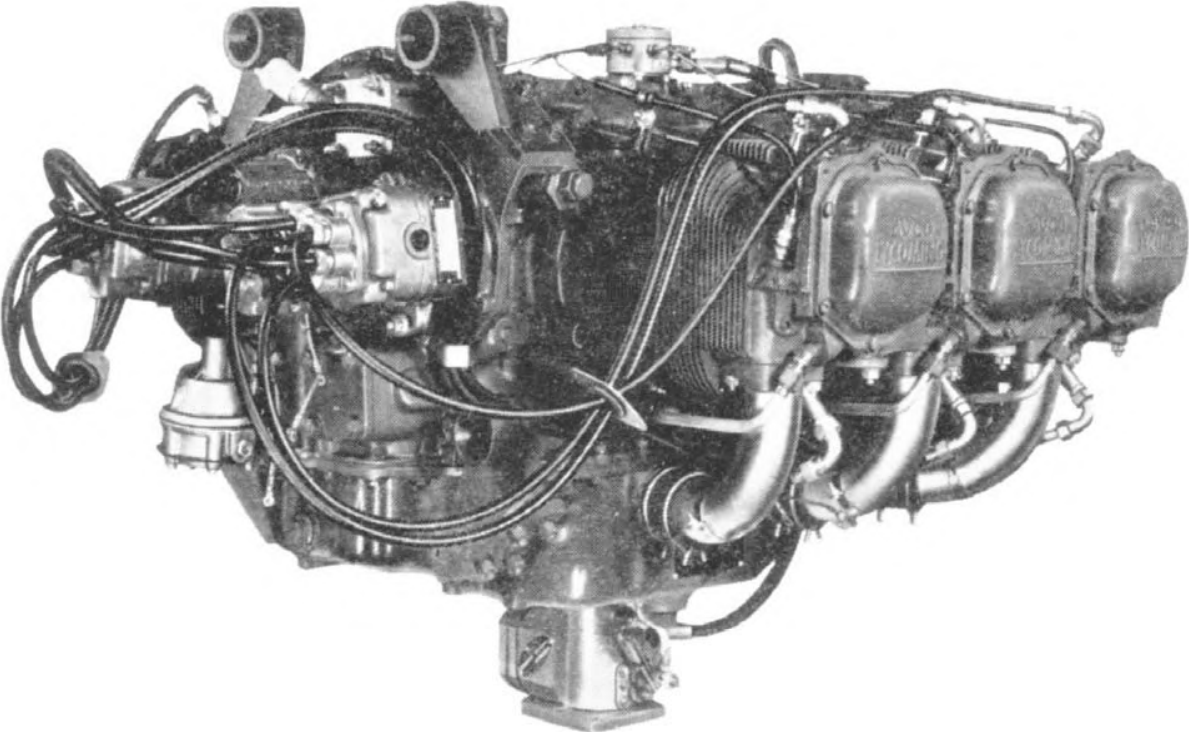

3/4 Right Rear View – Typical IO-540-C

LYCOMING OPERATOR'S MANUAL

WARNING

THESE ENGINES ARE EQUIPPED WITH A DYNAMIC COUNTERWEIGHT SYSTEM AND MUST BE OPERATED ACCORDINGLY; AVOID HIGH ENGINE SPEED, LOW MANIFOLD PRESSURE OPERATION. USE A SMOOTH, STEADY MOVEMENT OF THE THROTTLE (AVOID RAPID OPENING AND CLOSING). IF THIS WARNING IS NOT HEDED, THERE COULD BE SEVERE DAMAGE TO THE COUNTERWEIGHTS, ROLLER AND BUSHINGS.

This Page Intentionally Left Blank.

LYCOMING OPERATOR'S MANUAL

SECTION 1 DESCRIPTION

	Page
General.....	1-1
Cylinders.....	1-1
Valve Operating Mechanism	1-1
Crankcase	1-1
Crankshaft.....	1-1
Connecting Rods	1-1
Pistons	1-1
Accessory Housing	1-1
Oil Sump	1-2
Oil Sump and Induction System.....	1-2
Cooling System.....	1-2
Induction System.....	1-2

This Page Intentionally Left Blank.

SECTION 1

DESCRIPTION

The O-540 and IO-540 series are six cylinder, direct drive, horizontally opposed, air cooled engines.

In referring to the location of the various engine components, the parts are described in their relationship to the engine as installed in the airframe. Thus the power take-off end is considered the front; the accessory drive end, the rear. The sump section is considered the bottom and the opposite side of the engine where the shroud tubes are located the top. Reference to the left and right side is made with the observer facing the rear of the engine. The cylinders are numbered from front to rear, odd numbers on the right, even numbers on the left. The direction of rotation for accessory drives is determined with the observer facing the drive pad.

Cylinders – The cylinders are of conventional air cooled construction with the two major parts, head and barrel, screwed and shrunk together. The heads are made from an aluminum alloy casting with a fully machined combustion chamber. Rocker shaft bearing supports are cast integral with the head along with housings to form the rocker boxes for both valve rockers. The cylinder barrels, which are machined from chrome nickel molybdenum steel forgings, have deep integral cooling fins and the inside of the barrels are ground and honed to a specified finish.

Valve Operating Mechanism – A conventional type camshaft is located above and parallel to the crankshaft. The camshaft actuates hydraulic tappets which operate the valves through push rods and valve rockers. The valve rockers are supported on full-floating steel shafts. The valve springs bear against hardened steel seats and are retained on the valve stems by means of split keys.

Crankcase – The crankcase assembly consists of two reinforced aluminum alloy castings, fastened together by means of studs, bolts and nuts. The mating surfaces of the two castings are joined without the use of a gasket, and the main bearing bores are machined for use of precision type main bearing inserts.

Crankshaft – The crankshaft is made from a chrome nickel molybdenum steel forging. All bearing journal surfaces are nitrided. Freedom from torsional vibration is assured by a system of pendulum type dynamic counterweights.

Connecting Rods – The connecting rods are made in the form of “H” sections from alloy steel forgings. They have replaceable bearing inserts in the crankshaft ends and bronze bushings in the piston ends. The bearing caps on the crankshaft ends are retained by two bolts and nuts through each cap.

Pistons – The pistons are machined from an aluminum alloy forging. The piston pin is a full floating type with a plug located in each end of the pin. Depending on the cylinder assembly, pistons may be machined for either three or four rings and may employ either half-wedge or full-wedge rings. Consult the latest revision of Service Instruction No. 1037 for proper piston and ring combinations.

Accessory Housing – The accessory housing is made from an aluminum casting and is fastened to the rear of the crankcase and the top rear of the sump. It forms a housing for the oil pump and the various accessory drives.

SECTION 1
DESCRIPTION

LYCOMING OPERATOR'S MANUAL
O-540, IO-540 SERIES

Oil Sump (O-540, IO-540-C, -D, -J, -N, -R) – The sump incorporates an oil drain plug, oil suction screen, mounting pad for carburetor or fuel injector, the intake riser and intake pipe connections.

Oil Sump and Induction Assembly (Except O-540, IO-540-C, -D, -J, -N, -R) – This assembly consists of the oil sump bolted to a mated cover containing intake pipe extensions for the induction system. When bolted together they form a mounting pad for the air inlet housing. Fuel drain plugs are provided in the cover and the sump incorporates oil drain plugs and an oil suction screen.

Cooling System – These engines are designed to be cooled by air pressure actuated by the forward speed of the aircraft. Baffles are provided to build up a pressure and force the air through the cylinder fins. The air is then exhausted to the atmosphere through gills or augmentor tubes usually located at the rear of the cowling.

Induction System – Lycoming O-540 series engines are equipped with a Marvel-Schebler MA-4-5 carburetor. Particularly good distribution of the fuel-air mixture to each cylinder is obtained through the center zone induction system, which is integral with the oil sump and is submerged in oil, insuring a more uniform vaporization of fuel and aiding in cooling the oil in the sump. From the riser the fuel-air mixture is distributed to each cylinder by individual intake pipes.

Lycoming IO-540 series engines are equipped with either a Bendix type RS or RSA fuel injector. The fuel injection system schedules fuel flow in proportion to air flow and fuel vaporization takes place at the intake ports.

A brief description of the carburetor and fuel injectors follows:

The Marvel-Schebler MA-4-5 carburetor is of the single barrel float type and is equipped with a manual mixture control and an idle cut-off.

The Marvel-Schebler HA-6 is a horizontal mounted carburetor equipped with a manual mixture control and idle cut-off.

The Bendix RS type fuel injection system operates by measuring the air flow through the throttle body of the servo valve regulator controls, and uses this measurement to operate a servo valve within the control. The regulated fuel pressure established by the servo valve is used to control the distributor valve assembly, which then schedules fuel flow in proportion to air flow.

The Bendix RSA type fuel injection system is based on the principle of measuring air flow and using the air flow signal in a stem type regulator to convert the air force into a fuel force. This fuel force (fuel pressure differential) when applied across the fuel metering section (jetting system) makes fuel flow proportional to air flow.

NOTE

The letter "D" used as the 4th or 5th character in the model suffix means that the basic model configuration has been altered by the use of dual magnetos housed in a single housing. Example – basic model IO-540-K1A5 becomes IO-540-K1A5D.

Operational aspects of engines are the same, and performance data for the basic model still apply.

LYCOMING OPERATOR'S MANUAL

SECTION 2 SPECIFICATIONS

	Page
O-540-A, -B, -E, -G, -H Series.....	2-1
O-540-F, -J, -L Series; IO-540-A, -B, -E, -G, -P Series.....	2-2
IO-540-C, -D, -J, -N, -R, -T, -V Series.....	2-3
IO-540-K, -L, -M, -S, -W, -AA Series.....	2-4
IO-540-AB, -AC, -AE Series	2-5
Standard Engine Weights	2-6
Accessory Drives	2-7

This Page Intentionally Left Blank.

**SECTION 2
SPECIFICATIONS**

O-540-A* SERIES

FAA Type Certificate	295
Rated horsepower.....	250
Rated speed RPM.....	2575
Bore, inches.....	5.125
Stroke, inches.....	4.375
Displacement, cubic inches.....	541.5
Compression ratio	8.5:1
Firing order	1-4-5-2-3-6
Spark occurs, degrees BTC.....	25
Valve rocker clearance (hydraulic tappets collapsed)028-.080
Prop. drive ratio	1:1
Prop. driven rotation	Clockwise

O-540-B SERIES

FAA Type Certificate	295
Rated horsepower.....	235
Rated speed RPM.....	2575
Bore, inches.....	5.125
Stroke, inches.....	4.375
Displacement, cubic inches.....	541.5
Compression ratio	7.2:1
Firing order	1-4-5-2-3-6
Spark occurs, degrees BTC.....	25
Valve rocker clearance (hydraulic tappets collapsed)028-.080
Prop. drive ratio	1:1
Prop. driven rotation	Clockwise

O-540-E, -G, -H SERIES

FAA Type Certificate	295
Rated horsepower.....	260
Rated speed RPM.....	2700
Bore, inches.....	5.125
Stroke, inches.....	4.375
Displacement, cubic inches.....	541.5
Compression ratio	8.5:1
Firing order	1-4-5-2-3-6
Spark occurs, degrees BTC.....	25
Valve rocker clearance (hydraulic tappets collapsed)028-.080
Prop. drive ratio	1:1
Prop. driven rotation	Clockwise

* - O-540-A series engines (except –A3D5) has an alternate rating of 235 horsepower at 2400 RPM.

SPECIFICATIONS (CONT.)

O-540-J, -L SERIES

FAA Type Certificate	295
Rated horsepower.....	235
Rated speed RPM.....	2400
Bore, inches.....	5.125
Stroke, inches.....	4.375
Displacement cubic inches.....	541.5
Compression ratio	8.5:1
Firing order	1-4-5-2-3-6
Spark occurs, degrees BTC.....	23
Valve rocker clearance (hydraulic tappets collapsed)028-.080
Prop. drive ratio	1:1
Prop. driven rotation	Clockwise

O-540-F SERIES

FAA Type Certificate	295
Rated horsepower.....	235
Rated speed RPM.....	2800
Bore, inches.....	5.125
Stroke, inches.....	4.375
Displacement cubic inches.....	541.5
Compression ratio	8.5:1
Firing order	1-4-5-2-3-6
Spark occurs, degrees BTC.....	25
Valve rocker clearance (hydraulic tappets collapsed)028-.080
Prop. drive ratio	1:1
Prop. driven rotation	Clockwise

IO-540-A, -B, -E, -G, -P SERIES

FAA Type Certificate	1E4
Rated horsepower.....	290
Rated speed RPM.....	2575
Bore, inches.....	5.125
Stroke, inches.....	4.375
Displacement cubic inches.....	541.5
Compression ratio	8.7:1
Firing order	1-4-5-2-3-6
Spark occurs, degrees BTC.....	20
Valve rocker clearance (hydraulic tappets collapsed)028-.080
Prop. drive ratio	1:1
Prop. driven rotation	Clockwise

SPECIFICATIONS (CONT.)

IO-540-D, -N, -R, -T*, -V SERIES

FAA Type Certificate	1E4
Rated horsepower.....	260
Rated speed RPM.....	2700
Bore, inches.....	5.125
Stroke, inches.....	4.375
Displacement, cubic inches.....	541.5
Compression ratio	8.5:1
Firing order	1-4-5-2-3-6
Spark occurs, degrees BTC.....	25
Valve rocker clearance (hydraulic tappets collapsed)028-.080
Prop. drive ratio	1:1
Prop. driven rotation	Clockwise

* - IO-540-T4B5 model engine has an alternate rating of 250 horsepower at 2575 RPM. When operated at alternate rating, all performance data pertinent to the IO-540-C series is applicable.

IO-540-C* SERIES

FAA Type Certificate	1E4
Rated horsepower.....	250
Rated speed RPM.....	2575
Bore, inches.....	5.125
Stroke, inches.....	4.375
Displacement, cubic inches.....	541.5
Compression ratio	8.5:1
Firing order	1-4-5-2-3-6
Spark occurs, degrees BTC.....	25
Valve rocker clearance (hydraulic tappets collapsed)028-.080
Prop. drive ratio	1:1
Prop. driven rotation	Clockwise

* - IO-540-C4D5D model engine has an alternate rating of 235 horsepower at 2400 RPM. When operated at alternate rating, all performance data pertinent to the IO-540-W series is applicable.

IO-540-J SERIES

FAA Type Certificate	1E4
Rated horsepower.....	250
Rated speed RPM.....	2575
Bore, inches.....	5.125
Stroke, inches.....	4.375
Displacement, cubic inches.....	541.5
Compression ratio	8.5:1
Firing order	1-4-5-2-3-6
Spark occurs, degrees BTC.....	25
Valve rocker clearance (hydraulic tappets collapsed)028-.080
Prop. drive ratio	1:1
Prop. driven rotation	Clockwise

SPECIFICATIONS (CONT.)

IO-540-K*, -L, -M, -S* SERIES

FAA Type Certificate	1E4
Rated horsepower.....	300
Rated speed RPM.....	2700
Bore, inches.....	5.125
Stroke, inches.....	4.375
Displacement, cubic inches.....	541.5
Compression ratio	8.7:1
Firing order	1-4-5-2-3-6
Spark occurs, degrees BTC.....	20
Valve rocker clearance (hydraulic tappets collapsed)028-.080
Prop. drive ratio	1:1
Prop. driven rotation	Clockwise

* - IO-540-K1C5, -K1F5, -K1J5 and -S1A5 model engines have alternate rating of 290 horsepower at 2575 RPM. When operated at alternate rating, all performance data pertinent to the IO-540-G series is applicable.

IO-540-W SERIES

FAA Type Certificate	1E4
Rated horsepower.....	235
Rated speed RPM.....	2400
Bore, inches.....	5.125
Stroke, inches.....	4.375
Displacement, cubic inches.....	541.5
Compression ratio	8.5:1
Firing order	1-4-5-2-3-6
Spark occurs, degrees BTC.....	23
Valve rocker clearance (hydraulic tappets collapsed)028-.080
Prop. drive ratio	1:1
Prop. driven rotation	Clockwise

IO-540-AA SERIES

FAA Type Certificate	1E4
Rated horsepower.....	250
Rated speed RPM.....	2425
Bore, inches.....	5.125
Stroke, inches.....	4.375
Displacement, cubic inches.....	541.5
Compression ratio	7.3:1
Firing order	1-4-5-2-3-6
Spark occurs, degrees BTC.....	20
Valve rocker clearance (hydraulic tappets collapsed)028-.080
Prop. drive ratio	1:1
Prop. driven rotation	Clockwise

SPECIFICATIONS (CONT.)

IO-540-AB SERIES

FAA Type Certificate	1E4
Rated horsepower.....	230
Rated speed RPM.....	2400
Bore, inches.....	5.125
Stroke, inches.....	4.375
Displacement, cubic inches.....	541.5
Compression ratio	8.5:1
Firing order	1-4-5-2-3-6
Spark occurs, degrees BTC.....	23
Valve rocker clearance (hydraulic tappets collapsed)028-.080
Prop. drive ratio	1:1
Prop. driven rotation	Clockwise

IO-540-AC SERIES

FAA Type Certificate	1E4
Rated horsepower.....	300
Rated speed RPM.....	2700
Bore, inches.....	5.125
Stroke, inches.....	4.375
Displacement, cubic inches.....	541.5
Compression ratio	8.7:1
Firing order	1-4-5-2-3-6
Spark occurs, degrees BTC.....	20
Valve rocker clearance (hydraulic tappets collapsed)028-.080
Prop. drive ratio	1:1
Prop. driven rotation	Clockwise

IO-540-AE SERIES

FAA Type Certificate	1E4
Rated horsepower.....	235
Rated speed RPM.....	2800
Bore, inches.....	5.125
Stroke, inches.....	4.375
Displacement, cubic inches.....	541.5
Compression ratio	8.5:1
Firing order	1-4-5-2-3-6
Spark occurs, degrees BTC.....	20
Valve rocker clearance (hydraulic tappets collapsed)028-.080
Prop. drive ratio	1:1
Prop. driven rotation	Clockwise

**SECTION 2
SPECIFICATIONS**

**LYCOMING OPERATOR'S MANUAL
O-540, IO-540 SERIES**

1. STANDARD ENGINE, DRY WEIGHT

MODEL	LBS.
O-540-L3C5D	387.00
O-540-J1A5D, -J2A5D, -J1B5D, -J2B5D	387.00
O-540-J3A5D, -J3C5D	388.00
O-540-B1A5, -B2A5, -B4A5.....	395.00
O-540-B1B5, -B2B5, -B4B5, -J3A5.....	395.00
O-540-A2B, -B1D5.....	396.00
O-540-F1B5	400.00
O-540-B2C5, -E4A5	402.00
O-540-E4B5	403.00
O-540-E4C5	404.00
O-540-A1A, -A1A5, -A4A5	405.00
O-540-A1B5, -A1C5, -A4B5.....	406.00
O-540-A1D, -A4C5, -A1D5, -A4D5	406.00
O-540-A3D5, -H1B5D, -H2B5D.....	412.00
O-540-G1A5, -G2A5	415.00
O-540-H1A5, -H2A5	416.00
<hr/>	
IO-540-AB1A5	382.00
IO-540-W1A5, -W1A5D	400.00
IO-540-W3A5D	401.00
IO-540-C1C5, -C2C, -C4C5, -C4D5	402.00
IO-540-C1B5, -C4B5.....	404.00
IO-540-J4A5	409.00
IO-540-C4B5D, -C4D5D.....	410.00
IO-540-D4A5, -D4B5, -T4A5D, -T4B5D	412.00
IO-540-V4A5D	414.00
IO-540-T4B5.....	418.00
IO-540-T4C5D.....	424.00
IO-540-N1A5	428.00
IO-540-R1A5	437.00
IO-540-B1A5, -B1C5, -E1A5.....	442.00
IO-540-A1A5, -E1B5	443.00
IO-540-E1C5, -G1A5, -AE1A5.....	447.00
IO-540-G1E5	448.00
IO-540-G1F5.....	449.00
IO-540-G1B5	453.00
IO-540-G1C5, -G1D5, -AC1A5	454.00
IO-540-P1A5.....	455.00
IO-540-K1E5D	466.00
IO-540-M1A5, -M1B5D.....	467.00
IO-540-K1G5, -K1H5, -K1J5D, -L1A5D, -M1C5.....	468.00
IO-540-K1A5, -K2A5, -K1B5, -K1C5, -K1K5.....	469.00
IO-540-K1F5D, -K1G5D.....	469.00
IO-540-K1E5, -K1A5D	470.00

1. STANDARD ENGINE DRY WEIGHT (CONT.)

MODEL	LBS.
IO-540-L1C5, -L1B5D	471.00
IO-540-K1J5	472.00
IO-540-K1D5, -K1F5	473.00
IO-540-S1A5.....	475.00
IO-540-AA1A5, -AA1B5	479.00

1. ACCESSORY DRIVES

*Accessory Drive	Drive Ratio	**Direction of Rotation
Starter	16.556:1	Counterclockwise
Generator	1.910:1	Clockwise
Generator (Optional)	2.500:1	Clockwise
Alternator	3.200:1	Clockwise
Alternator (Optional)	3.630:1	Clockwise
Vacuum Pump	1.300:1	Counterclockwise
Hydraulic Pump	1.385:1	Clockwise
Hydraulic Pump†	1.300:1	Clockwise
Tachometer	.500:1	Clockwise
Propeller Governor	.895:1	Clockwise
Propeller Governor‡	.947:1	Clockwise
Magneto Drive: Single	1.500:1	Clockwise
Magneto Drive: Dual	.750:1	Clockwise
Fuel Pump – AN (Single Mag)	1.000:1	Counterclockwise
Fuel Pump – AN (Dual Mag)	1.000:1	Clockwise
Fuel Pump – Plunger Operated	.500:1	Counterclockwise

* - When applicable.

** - Viewed facing drive pad – NOTE that engines with “L” in prefix will have opposite rotation to the above.

† - Dual magneto drive.

‡ - Wide cylinder flange series.

This Page Intentionally Left Blank.

LYCOMING OPERATOR'S MANUAL

**SECTION 3
OPERATING INSTRUCTIONS**

	Page
General.....	3-1
Prestarting Items of Maintenance	3-1
Starting Procedures	3-1
Cold Weather Starting	3-2
Ground Running and Warm-Up	3-2
Ground Check	3-2
Operating in Flight	3-4
Use of Carburetor Heat Control.....	3-7
Engine Flight Chart	3-8
Operating Conditions	3-9
Engine Shut Down Procedures	3-13
Performance Curves	3-14

This Page Intentionally Left Blank.

SECTION 3

OPERATING INSTRUCTIONS

1. *GENERAL.* Close adherence to these instructions will greatly contribute to long life, economy and satisfactory operation of the engine.

NOTE

YOUR ATTENTION IS DIRECTED TO THE WARRANTIES THAT APPEAR IN THE FRONT OF THIS MANUAL REGARDING ENGINE SPEED, THE USE OF SPECIFIED FUELS AND LUBRICANTS, REPAIR AND ALTERATIONS. PERHAPS NO OTHER ITEM OF ENGINE OPERATION AND MAINTENANCE CONTRIBUTES QUITE SO MUCH TO SATISFACTORY PERFORMANCE AND LONG LIFE AS THE CONSTANT USE OF CORRECT GRADES OF FUEL AND OIL, CORRECT ENGINE TIMING, AND FLYING THE AIRCRAFT AT ALL TIMES WITHIN THE SPEED AND POWER RANGE SPECIFIED FOR THE ENGINE. DO NOT FORGET THAT VIOLATION OF THE OPERATION AND MAINTENANCE SPECIFICATIONS FOR YOUR ENGINE WILL NOT ONLY VOID YOUR WARRANTY BUT WILL SHORTEN THE LIFE OF YOUR ENGINE AFTER ITS WARRANTY PERIOD HAS PASSED.

New engines have been carefully run-in by Lycoming and therefore, no further break-in is necessary insofar as operation is concerned; however, new or newly overhauled engines should be operated using only the lubricating oils recommended in the latest revision of Service Instruction No. 1014.

NOTE

Cruising should be done at 65% to 75% power until a total of 50 hours has been accumulated or the oil consumption has stabilized. This is to insure the proper seating of the rings and is applicable to new engines and engines in service following cylinder replacement or top overhaul of one or more cylinders.

The minimum fuel octane rating is listed in the flight chart, Part 9 of this section. Under no circumstances should fuel of a lower octane rating or automotive fuel (regardless of octane rating) be used.

2. *PRESTARTING ITEMS OF MAINTENANCE.* Before starting the aircraft engines for the first flight of the day; there are several items of maintenance inspection that should be performed. These are described in Section 4 under Daily Pre-Flight Inspection. They must be observed before the engine is started.

3. *STARTING PROCEDURES.*

The following starting procedures are recommended; however, the starting characteristics of various installations will necessitate some variation from these procedures.

NOTE

Cranking periods should be limited from ten (10) to twelve (12) seconds with 5 minutes rest between cranking periods.

**SECTION 3
OPERATING INSTRUCTIONS**

**LYCOMING OPERATOR'S MANUAL
O-540, IO-540 SERIES**

a. O-540 Series

- (1) Perform pre-flight inspection.
- (2) Set carburetor heat control in "cold" position.
- (3) Set propeller governor (if applicable) in "Full RPM" position.
- (4) Turn fuel valve to "on" position.
- (5) Move mixture control to "Full Rich".
- (6) Turn on boost pump.
- (7) Pump throttle to full open and back to idle position for 2 to 3 strokes for a cold engine. If engine is equipped with a priming system, cold engines may be primed with 1 to 3 strokes of the priming pump.
- (8) Open throttle approximately $\frac{1}{4}$ travel.
- (9) Set magneto selector switch. Consult airframe manufacturer's handbook for correct position.
- (10) Engage starter.
- (11) When engine starts, place magneto selector switch in "Both" position.
- (12) Check oil pressure gage for indicated pressure. If oil pressure is not indicated within thirty seconds, stop engine and determine trouble.

b. IO-540 Series (Cold Engine).

- (1) Perform pre-flight inspection.
- (2) Set propeller governor in "Full RPM".
- (3) Turn fuel valve to "on" position.
- (4) Open throttle approximately $\frac{1}{4}$ travel.
- (5) Turn boost pump on and move mixture control to "Full Rich" position until a slight but steady flow is indicated.
- (6) Return mixture control to "Idle Cut-Off" position.
- (7) Set magneto selector switch. Consult airframe manufacturer's handbook for correct position.
- (8) Engage starter.

- (9) When engine starts, place magneto selector switch in "Both" position.
- (10) Move mixture control slowly and smoothly to "Full Rich".
- (11) Check oil pressure gage for indicated pressure. If oil pressure is not indicated within thirty seconds, stop the engine and determine trouble.

NOTE

If engine fails to achieve a normal start, assume it to be flooded. Crank engine over with throttle wide open and ignition off. Then repeat above procedure.

Hot Engine – Because fuel percolates, the system must be cleared of vapor; it is recommended that the same procedure, as outlined on page 3-2, be used for starting a hot engine.

4. *COLD WEATHER STARTING.* During extreme cold weather, it may be necessary to preheat the engine and oil before starting.

5. *GROUND RUNNING AND WARM-UP.* Subject engines are air pressure cooled and depend on the forward movement of the aircraft to maintain proper cooling. Particular care is necessary, therefore, when operating these engines on the ground. To prevent overheating, it is recommended that the following precautions be observed.

NOTE

Any ground check that requires full throttle operation must be limited to three minutes, or less if indicated cylinder head temperature should exceed the maximum stated in this manual.

- a. Head the aircraft into the wind.
 - b. Leave mixture in "Full Rich".
 - c. Operate the engine on the ground only with the propeller in minimum blade angle setting.
 - d. Warm up at approximately 1000-1200 RPM. Avoid prolonged idling and do not exceed 2200 RPM on the ground.
 - e. Engine is warm enough for take-off when the throttle can be opened without the engine faltering.
6. *GROUND CHECK.*
- a. Warm up as directed above.
 - b. Check both oil pressure and oil temperature.
 - c. Leave mixture in "Full Rich".

- d. (Where applicable) Move the propeller control through its complete range to check operation and return to full low pitch position. Full feathering check (twin engine) on the ground is not recommended but the feathering action can be checked by running the engine between 1000-1500 RPM; then momentarily pulling the propeller control into the feathering position. Do not allow the RPM to drop more than 500 RPM.
- e. A proper magneto check is important. Additional factors, other than the ignition system, affect magneto drop-off. They are load-power output, propeller pitch and mixture strength. The important thing is that the engine runs smoothly because magneto drop-off is affected by the variables listed above. Make the magneto check in accordance with the following procedures.
 - (1) (Controllable Pitch Propeller) With propeller in minimum pitch angle, set the engine to produce 50-65% power as indicated by the manifold pressure gage unless other specified in the aircraft manufacturer's manual. Set the mixture control to the full rich position. At these settings, the ignition system and spark plugs must work harder because of the greater pressure within the cylinders. Under these conditions, ignition problems can occur. Mag checks at low power settings will only indicate fuel-air distribution quality.

NOTE

Aircraft that are equipped with fixed pitch propellers, or not equipped with manifold pressure gage, may check magneto drop-off with engine operating at approximately 2100-2200 RPM.

- (2) Switch from both magnetos to one and note drop-off; return to both until engine regains speed and switch to the other magneto and note drop-off, then return to both. Drop-off should not exceed 175 RPM and should not exceed 50 RPM between magnetos. A smooth drop-off past the normal specification of 175 RPM is usually a sign of a too lean or too rich mixture.
 - (3) If the RPM drop exceeds 175 RPM, slowly lean the mixture until the RPM peaks. Then retard the throttle to the RPM specified in step e. (1) for the magneto check and repeat the check. If the drop-off does not exceed 175 RPM, the difference between the magnetos does not exceed 50 RPM, and the engine is running smoothly, then the ignition system is operating properly. Return the mixture to full rich.
- f. Do not operate on a single magneto for too long a period; a few seconds is usually sufficient to check drop-off and will minimize plug fouling.

7. *OPERATING IN FLIGHT.*

- a. Subject engines are equipped with a dynamic counterweight system and must be operated accordingly. Use a smooth, steady movement (avoid rapid opening and closing) of the throttle.
- b. See airframe manufacturer's instructions for recommended power settings.
- c. Fuel Mixture Leaning Procedure.

Improper fuel/air mixture during flight is responsible for many engine problems, particularly during take-off and climb power settings. The procedures described in this manual provide proper fuel/air mixture when leaning Lycoming engines; they have proven to be both economical and practical by eliminating excessive fuel consumption and reducing damaged parts replacement. It is therefore recommended that operators of all Lycoming aircraft power-plants utilize the instructions in this publication any time the fuel/air mixture is adjusted during flight.

Manual leaning may be monitored by exhaust gas temperature indication, fuel flow indication, and by observation of engine speed and/or airspeed. However, whatever instruments are used in leaning the mixture, the following general rules should be observed by the operator of Lycoming aircraft engines.

GENERAL RULES

Never exceed the maximum red line cylinder head temperature limit.

For maximum service life, cylinder head temperatures should be maintained below 435°F (224°C) during high performance cruise operation and below 400°F (205°C) for economy cruise powers.

On engines with manual mixture control, maintain mixture control in "Full Rich" position for rated take-off, climb and maximum cruise powers (above approximately 75%). However, during take-off from high elevation airport or during climb, roughness or loss of power may result from over-richness. In such a case adjust mixture control only enough to obtain smooth operation – not for economy. Observe instruments for temperature rise. Rough operation due to over-rich fuel/air mixture is most likely to be encountered at altitudes above 5,000 feet.

Always return the mixture to full rich before increasing power settings.

Operate the engine at maximum power mixture for performance cruise powers and at best economy mixture for economy cruise power; unless otherwise specified in the airplane owners manual.

During let-down flight operations it may be necessary to manually lean carbureted or fuel injected engines to obtain smooth operation.

A. LEANING TO EXHAUST GAS TEMPERATURE GAGE.

1. Normally aspirated engines with fuel injectors or carburetors.

(a) Maximum Power Cruise (approximately 75% power) – Never lean beyond 150°F on rich side of peak EGT unless aircraft operator's manual shows otherwise. Monitor cylinder head temperatures.

(b) Best Economy Cruise (approximately 75% power and below) – Operate at peak EGT.

B. LEANING TO FLOWMETER.

Lean to applicable fuel-flow tables or lean to indicator marked for correct fuel-flow for each power setting.

C. LEANING WITH MANUAL MIXTURE CONTROL (Without flowmeter or EGT gage).

1. Carbureted Engines.

(a) Slowly move mixture control from "Full Rich" position toward lean position.

(b) Continue leaning until engine roughness is noted.

(c) Enrich until engine runs smoothly and power is regained.

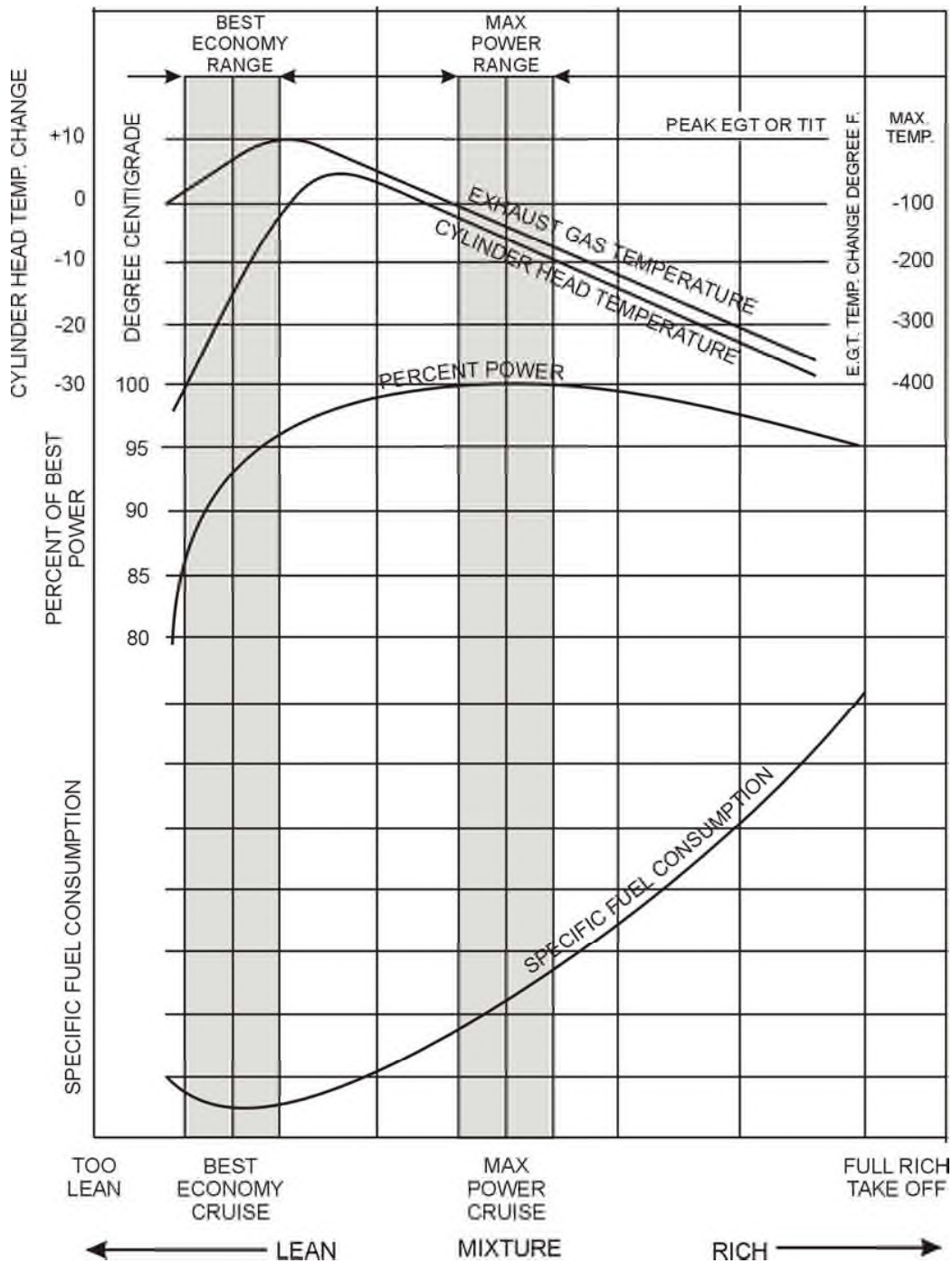

Figure 3-1. Representative Effect of Leaning on Cylinder Head Temperature, EGT (Exhaust Gas Temperature), Engine Power and Specific Fuel Consumption at Constant Engine RPM and Manifold Pressure



WARNING

REFER TO THE PILOT'S OPERATING HANDBOOK OR AIRFRAME MANUFACTURER'S MANUAL FOR ADDITIONAL INSTRUCTIONS ON THE USE OF CARBURETOR HEAT CONTROL. INSTRUCTIONS FOUND IN EITHER PUBLICATION SUPERSEDE THE FOLLOWING INFORMATION.

8. *USE OF CARBURETOR HEAT CONTROL (O-540 SERIES)* – Under certain moist atmospheric conditions (generally at a relative humidity of 50% or greater) and at temperatures of 20° to 90°F it is possible for ice to form in the induction system. Even in summer weather ice may form. This is due to the high air velocity through the carburetor venturi and the absorption of heat from this air by vaporization of the fuel. The temperature in the mixture chamber may drop as much as 70°F below the temperature of the incoming air. If this air contains a large amount of moisture, the cooling process can cause precipitation in the form of ice. Ice formation generally begins in the vicinity of the butterfly and may build up to such an extent that a drop in power output could result. In installations equipped with fixed pitch propellers, a loss of power is reflected by a drop in manifold pressure and RPM. In installations equipped with constant speed propellers, a loss of power is reflected by a drop in manifold pressure. If not corrected, this condition may cause complete engine stoppage.

To avoid this, all installations are equipped with a system for preheating the incoming air supply to the carburetor. In this way sufficient heat is added to replace the heat loss of vaporization of fuel, and the mixing chamber temperature cannot drop to the freezing point of water (32°F). The air preheater is a tube or jacket through which the exhaust pipe from one or more cylinders is passed, and the air flowing over these surfaces is raised to the required temperature before entering the carburetor. Consistently high temperatures are to be avoided because of a loss of power and a decided variation of mixture. High charge temperatures also favor detonation and preignition, both of which are to be avoided if normal service life is to be expected from the engine. The following outline is the proper method of utilizing the carburetor heat control.

- a. *Ground Operation* – Use of the carburetor air heat on the ground must be held to an absolute minimum. On some installations the air does not pass through the air filter, and dirt and foreign substances can be taken into the engine with the resultant cylinder and piston ring wear. Only use carburetor air heat on the ground to make certain it is functioning properly.
- b. *Take-Off* – Set the carburetor heat in full cold position. For take-off and full throttle operation the possibility of expansion or throttle icing at wide throttle openings is very remote.
- c. *Climbing* – When climbing at part throttle power settings of 80% or above, set the carburetor heat control in the full cold position; however, if it is necessary to use carburetor heat to prevent icing it is possible for engine roughness to occur due to the over-rich fuel/air mixture produced by the additional carburetor heat. When this happens, lean the mixture with the mixture control only enough to produce smooth engine operation. Do not continue to use carburetor heat after flight is out of icing conditions, and return mixture to full rich when carburetor heat is removed.
- d. *Flight Operation* – During normal flight, leave the carburetor air heat control in the full cold position. On damp, cloudy, foggy or hazy days, regardless of the outside air temperature, be alert for loss of power. This will be evidenced by an unaccountable loss in manifold pressure or RPM or both, depending on whether a constant speed or fixed pitch propeller is installed on the aircraft. If this happens, apply full carburetor air heat and open the throttle to limiting manifold pressure and RPM.

**SECTION 3
OPERATING INSTRUCTIONS**

**LYCOMING OPERATOR'S MANUAL
O-540, IO-540 SERIES**

This will result in a slight additional drop in manifold pressure, which is normal, and this drop will be regained as the ice is melted out of the induction system. When ice has been melted from the induction system, return the carburetor heat control to full cold position. In those aircraft equipped with a carburetor air temperature gauge, partial heat may be used to keep the mixture temperature above the freezing point of water (32°F).



CAUTION MUST BE EXERCISED WHEN OPERATING WITH PARTIAL HEAT ON AIRCRAFT THAT DO NOT HAVE A CARBURETOR AIR TEMPERATURE GAUGE. USE EITHER FULL HEAT OR NO HEAT IN AIRCRAFT THAT ARE NOT EQUIPPED WITH A CARBURETOR AIR TEMPERATURE GAUGE.

- e. *Landing Approach* – In making a landing approach, the carburetor heat is generally in the “Full Cold” position. However, if icing conditions are suspected, apply “Full Heat”. In the case that full power needs to be applied under these conditions, as for an aborted landing, return the carburetor heat to “Full Cold” after full power application.

9. *ENGINE FLIGHT CHART.*

-Fuel Requirements-

O-540 MODELS

*Aviation Grade Fuel

-B Series	80/87 Octane, Minimum
-A3D5, -E Series	91/96 Octane, Minimum
-A, -G, -H Series	91/96 or 100/100LL Octane, Minimum
-F, -J, -L Series	100/100LL Octane, Minimum

IO-540 MODELS

-C*, -D, -N, -V Series	91/96 or 100/100LL Octane, Minimum
-A, -B, -E, -G, -J, -K, -L, -M, -P, -R, -S, -T, -W, -AA, -AB, -AC, -AE Series	100/100LL Octane, Minimum

* - Refer to latest revision of Service Instruction No. 1070.

NOTE

Aviation grade 100LL fuels in which the lead content is limited to 2 c.c. per gal. are approved for continuous use in the above listed engines.

-Oil Requirements-

ALL MODELS

*Recommended Grade Oil

Average Ambient Air	MIL-6082B Grades	MIL-L-22851 Ashless Dispersant Grades
All Temperature	-----	SAE 15W-50 or 20W-50
Above 80°F (27°C)	SAE 60	SAE 60
Above 60°F (16°C)	SAE 50	SAE 40 or SAE 50
30°F to 90°F (-1°C to 32°C)	SAE 40	SAE 40
0°F to 70°F (18°C to 21°C)	SAE 30	SAE 40, 30, 20W-40
Below 10°F (12°C)	SAE 20	SAE 30, 20W-30

* - Refer to the latest revision of Service Instruction No. 1014.

Oil Sump Capacity

O-540 MODELS

All Series Except Below	12 U.S. Qts.
(Minimum safe quantity in sump)	2-3/4 U.S. Qts.
O-540-L3C5D, -J3C5D.....	8 U.S. Qts.
(Minimum safe quantity in sump)	2 U.S. Qts.

Refer to the latest revision of Service Bulletin No. 480 for oil and filter change and screen cleaning requirements.

9. ENGINE FLIGHT CHART (CONT.)

Oil Sump Capacity (Cont.)

IO-540 MODELS

All Series Except Below	12 U.S. Qts.
(Minimum safe quantity in sump).....	2-3/4 U.S. Qts.
IO-540-AB1A5, -T4A5D, -T4B5, -T4B5D, -V4A5D, -W1A5, -W1A5D, -W3A5D	8 U.S. Qts.
IO-540-T4C5D.....	8 U.S. Qts. (10 U.S. Qts. Max.)
IO-540-AC1A5	11 U.S. Qts.
(Minimum safe quantity in sump).....	2 U.S. Qts.
(Minimum safe quantity in sump - -AB1A5, -AC1A5).....	4 U.S. Qts.

Oil Pressure, psi	Max.	Min.	Idling	Start and Warm-Up
Normal Operation				
All Models	95	55	25	115

Oil Temperature: The maximum permissible oil temperature is 245°F (118°C). For maximum engine life, desired oil temperature should be maintained between 165°F (73.8°C) and 200°F (93.3°C) in level flight cruise conditions.

OPERATING CONDITIONS

FUEL PRESSURE (PSI)	MIN.	MAX.	IDLE MIN.
O-540 Series (Except -L3C5D)	0.5	8.0	-----
-L3C5D*	3	30	-----

* - Above compressor outlet pressure.

IO-540-AB1A5, -C1B5, -C1C5, -C4B5, -C4B5D, -C4D5, -C4D5D, -D4A5, -D4B5, -N1A5, -T4A5D, -T4B5, -T4B5D, -T4C5D, -V4A5D, -W1A5, -W1A5D, -W3A5D			
Inlet to fuel pump	-2	35	
Inlet to fuel injector	14	45	12
IO-540-K1G5, -K1H5			
Inlet to fuel pump	-2	35	
Inlet to fuel injector	20	40	12
IO-540-L1B5D			
Inlet to fuel pump	-2	40	12
Inlet to fuel injector	20	55	
IO-540-L1C5			
Inlet to fuel pump	-2	35	
Inlet to fuel injector	18	55	12
IO-540-M1A5, -M1C5			
Inlet to fuel pump	-2	55	
Inlet to fuel injector	18	55	12

**SECTION 3
OPERATING INSTRUCTIONS**

**LYCOMING OPERATOR'S MANUAL
O-540, IO-540 SERIES**

OPERATING CONDITIONS (CONT.)

FUEL PRESSURE (PSI)	MIN.	MAX.	IDLE MIN.
IO-540-A1A5, -B1A5, -B1C5, -E1A5, -E1B5, -G1A5, -G1E5, -G1F5, -K1C5, -K1E5, -K1E5D Inlet to fuel injector	20	26	-----
IO-540-AA1A5, -AA1B5 Inlet to fuel pump	-4	55	
Inlet to fuel injector	18	55	12
IO-540-AC1A5 Inlet to fuel pump	-2	65	
Inlet to fuel injector	29	65	12
IO-540-AE1A5 Inlet to fuel pump	-2	35	
Inlet to fuel injector	18	45	12

NOTE

All IO-540 models listed have 55 psi maximum to fuel pump inlet with the fuel injector in idle cut-off.

Operation	RPM	HP	Fuel Cons. Gal./Hr.	Max. Oil Cons. Qts./Hr.	*Max. Cyl. Head Temp.
<u>O-540-A Series</u>					
Normal Rated	2575	250	-----	0.83	500°F (260°C)
Performance Cruise (75% Rated)	2350	190	16.3	0.63	500°F (260°C)
Economy Cruise (60% Rated)	2200	150	12.5	0.50	500°F (260°C)
<u>O-540-B Series</u>					
Normal Rated	2575	235	-----	0.78	500°F (260°C)
Performance Cruise (75% Rated)	2350	175	15.5	0.58	500°F (260°C)
Economy Cruise (60% Rated)	2200	140	12.2	0.47	500°F (260°C)
<u>O-540-E, -G, -H</u>					
Normal Rated	2700	260	-----	0.87	500°F (260°C)
Performance Cruise (75% Rated)	2450	195	19.0	0.65	500°F (260°C)
Economy Cruise (60% Rated)	2350	155	14.0	0.52	500°F (260°C)

* - At Bayonet Location – For maximum service life of the engine maintain cylinder head temperature between 150°F and 435°F during continuous operation.

OPERATING CONDITIONS (CONT.)

Operation	RPM	HP	Fuel Cons. Gal/Hr.	Max. Oil Cons. Qts./Hr.	*Max. Cyl. Head Temp.
<u>O-540-F Series</u>					
Normal Rated	2800	235	-----	0.78	500°F (260°C)
Performance Cruise (75% Rated)	2800	175	15.0	0.58	500°F (260°C)
Economy Cruise (60% Rated)	2800	155	13.5	0.51	500°F (260°C)
<u>O-540-J Series**</u>					
Normal Rated	2400	235	-----	0.78	500°F (260°C)
Performance Cruise (75% Rated)	2200	175	14.0	0.58	500°F (260°C)
Economy Cruise (60% Rated)	2000	140	10.2	0.47	500°F (260°C)
<u>O-540-L3C5D***</u>					
Normal Rated	2400	235	-----	0.78	500°F (260°C)
Performance Cruise (75% Rated)	2200	175	15.0	0.58	500°F (260°C)
Economy Cruise (60% Rated)	2000	140	10.3	0.47	500°F (260°C)

* - At Bayonet Location – For maximum service life of the engine maintain cylinder head temperature between 150°F and 435°F during continuous operation.

** - Model O-540-J Engines – Manual leaning to best economy is permitted at cruise conditions up to 75% power resulting in a BSFC of .430 lbs./BHP./hr. Minimum allowable BSFC at take-off and climb conditions is .500 lbs./BHP./hr.

** - Model O-540-J3A5D Engines – Manual leaning is permitted at cruise conditions up to 85% power resulting in a BSFC of .420 lbs./BHP./hr. at best economy and .460 lbs./BHP./hr. at best power. Minimum allowable BSFC at take-off and climb conditions is .500 lbs./BHP./hr.

*** - Model O-540-L Engines – Manual leaning at best economy is permitted at cruise conditions up to 75% power resulting in a BSFC of .430 lbs./BHP./hr. Minimum allowable BSFC at take-off and climb is .550 lbs./BHP./hr.

**SECTION 3
OPERATING INSTRUCTIONS**

**LYCOMING OPERATOR'S MANUAL
O-540, IO-540 SERIES**

OPERATING CONDITIONS (CONT.)

Operation	RPM	HP	Fuel Cons. Gal./Hr.	Max. Oil Cons. Qts./Hr.	*Max. Cyl. Head Temp.
<u>IO-540-A, -B, -E, -G, -P Series</u>					
Normal Rated Performance Cruise (75% Rated)	2575	290	-----	0.97	500°F (260°C)
Economy Cruise (60% Rated)	2350	220	16.5	0.73	500°F (260°C)
	2200	175	12.0	0.5	500°F (260°C)
<u>IO-540-C, -J Series**</u>					
Normal Rated Performance Cruise (75% Rated)	2575	250	-----	0.83	500°F (260°C)
Economy Cruise (60% Rated)	2350	190	16.5	0.63	500°F (260°C)
	2200	150	12.5	0.50	500°F (260°C)
<u>IO-540-D, -N, -R, -T, -V Series</u>					
Normal Rated Performance Cruise (75% Rated)	2700	260	-----	0.87	500°F (260°C)
Economy Cruise (60% Rated)	2450	195	15.0	0.65	500°F (260°C)
	2350	155	12.0	0.52	500°F (260°C)
<u>IO-540-K, -L, -M, -S Series</u>					
Normal Rated Performance Cruise (75% Rated)	2700	300	-----	1.0	500°F (260°C)
Economy Cruise (60% Rated)	2450	225	18.0	0.75	500°F (260°C)
	2350	180	12.8	0.60	500°F (260°C)
<u>IO-540-W Series</u>					
Normal Rated Performance Cruise (75% Rated)	2400	235	-----	0.78	500°F (260°C)
Economy Cruise (60% Rated)	2200	175	12.5	0.58	500°F (260°C)
	2000	140	10.1	0.47	500°F (260°C)

* - At Bayonet Location – For maximum service life of the engine maintain cylinder head temperatures between 150°F and 435°F during continuous operation.

** - Limiting manifold pressure for continuous operation of IO-540-C4B5, -C4C5, -J4A5 with Hartzell propeller HCE2Y type hub and 8465-7R blades. Do not exceed 27 inches manifold pressure below 2300 RPM.

OPERATING CONDIITONS (CONT.)

Operation	RPM	HP	Fuel Cons. Gal./Hr.	Max. Oil Cons. Qts./Hr.	*Max. Cyl. Head Temp.
<u>IO-540-AA Series</u>					
Normal Rated	2425	250	-----	0.83	500°F (260°C)
Performance Cruise (75% Rated)	2200	190	14.5	0.63	500°F (260°C)
Economy Cruise (60% Rated)	1900	150	11.5	0.50	500°F (260°C)
<u>IO-540-AB Series</u>					
Normal Rated	2400	230	-----	0.78	500°F (260°C)
Performance Cruise (75% Rated)	2200	175	12.5	0.58	500°F (260°C)
Economy Cruise (60% Rated)	2000	140	10.1	0.47	500°F (260°C)
<u>IO-540-AC Series</u>					
Normal Rated	2700	300	23.7	0.98	500°F (260°C)
Performance Cruise (75% Rated)	2400	225	19.0	0.73	500°F (260°C)
Economy Cruise (60% Rated)	2200	180	12.6	0.58	500°F (260°C)
<u>IO-540-AE Series</u>					
Normal Rated	2800	235	-----	0.78	500°F (260°C)
Performance Cruise (75% Rated)	2800	175	15.0	0.58	500°F (260°C)
Economy Cruise (65% Rated)	2800	155	13.5	0.51	500°F (260°C)

* - At Bayonet Location – For maximum service life of the engine maintain cylinder head temperatures between 150°F and 435°F during continuous operation.

e. Engine Shut Down –

- (1) Set propeller at minimum blade angle.
- (2) Idle until there is a decided decrease in cylinder head temperature.
- (3) Move mixture control to “Idle Cut-Off”.
- (4) When engine stops, turn ignition switch off.

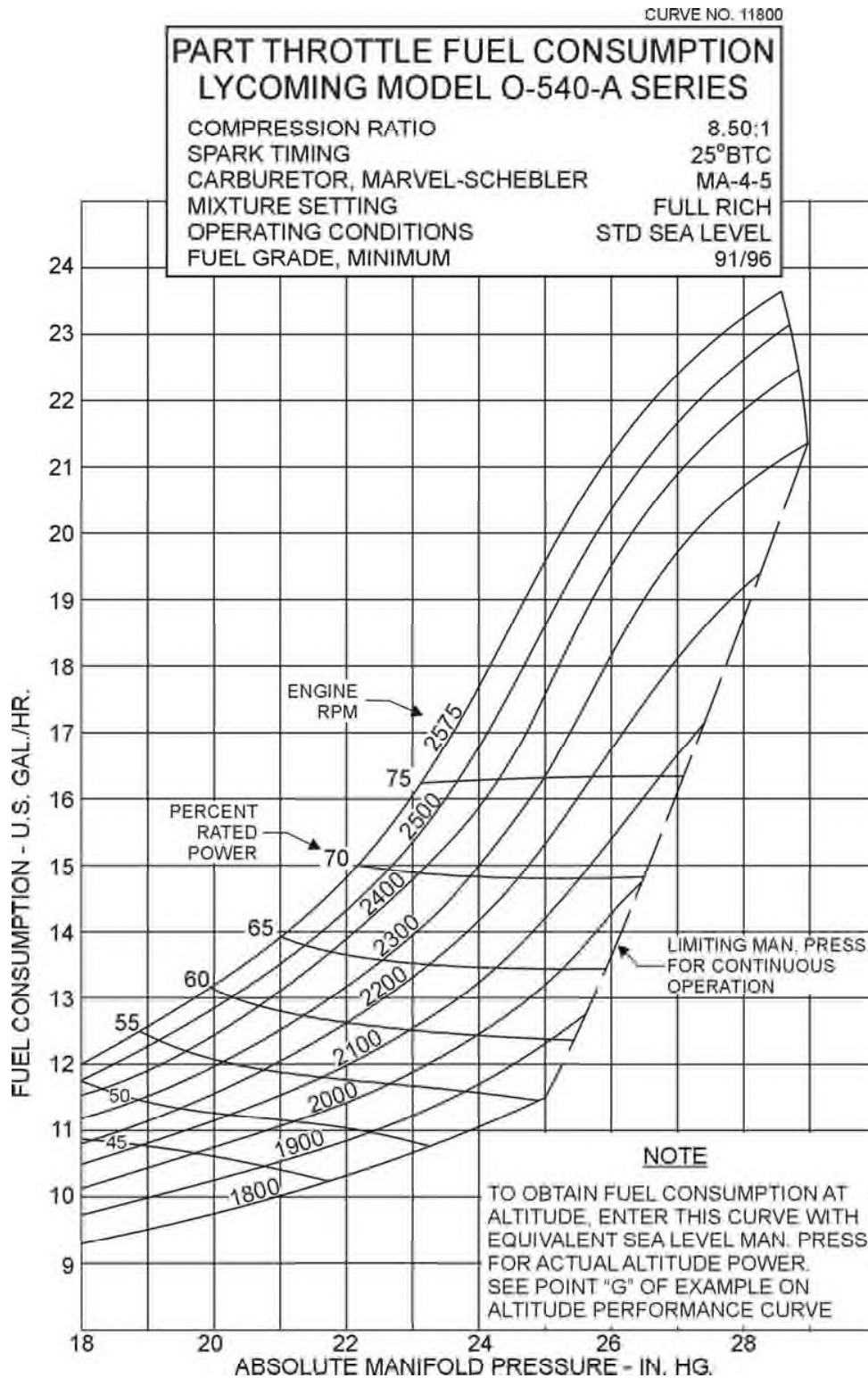

Figure 3-2. Part Throttle Fuel Consumption Curve –
O-540-A

CURVE NO. 11799

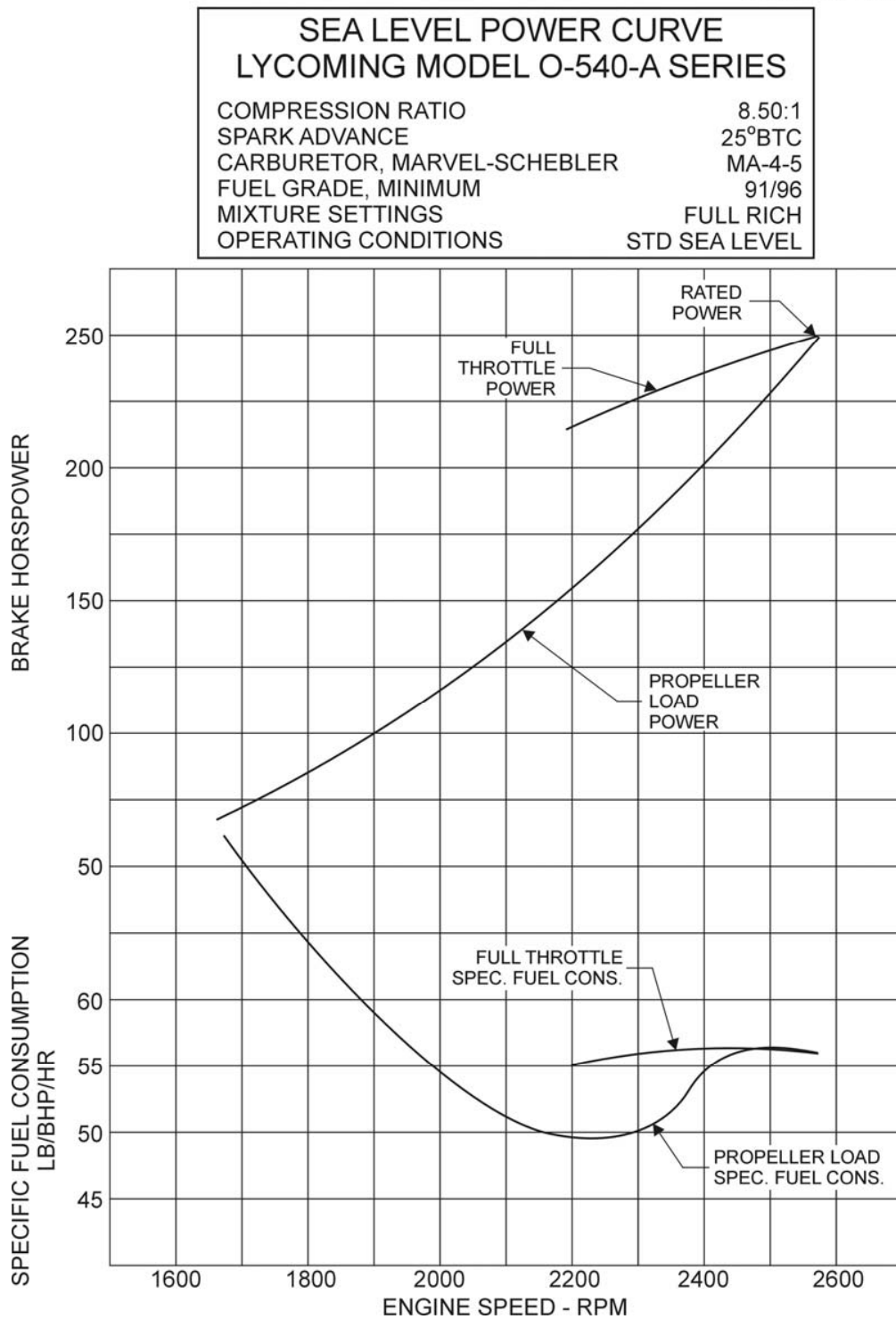

Figure 3-3. Sea Level Power Curve – O-540-A

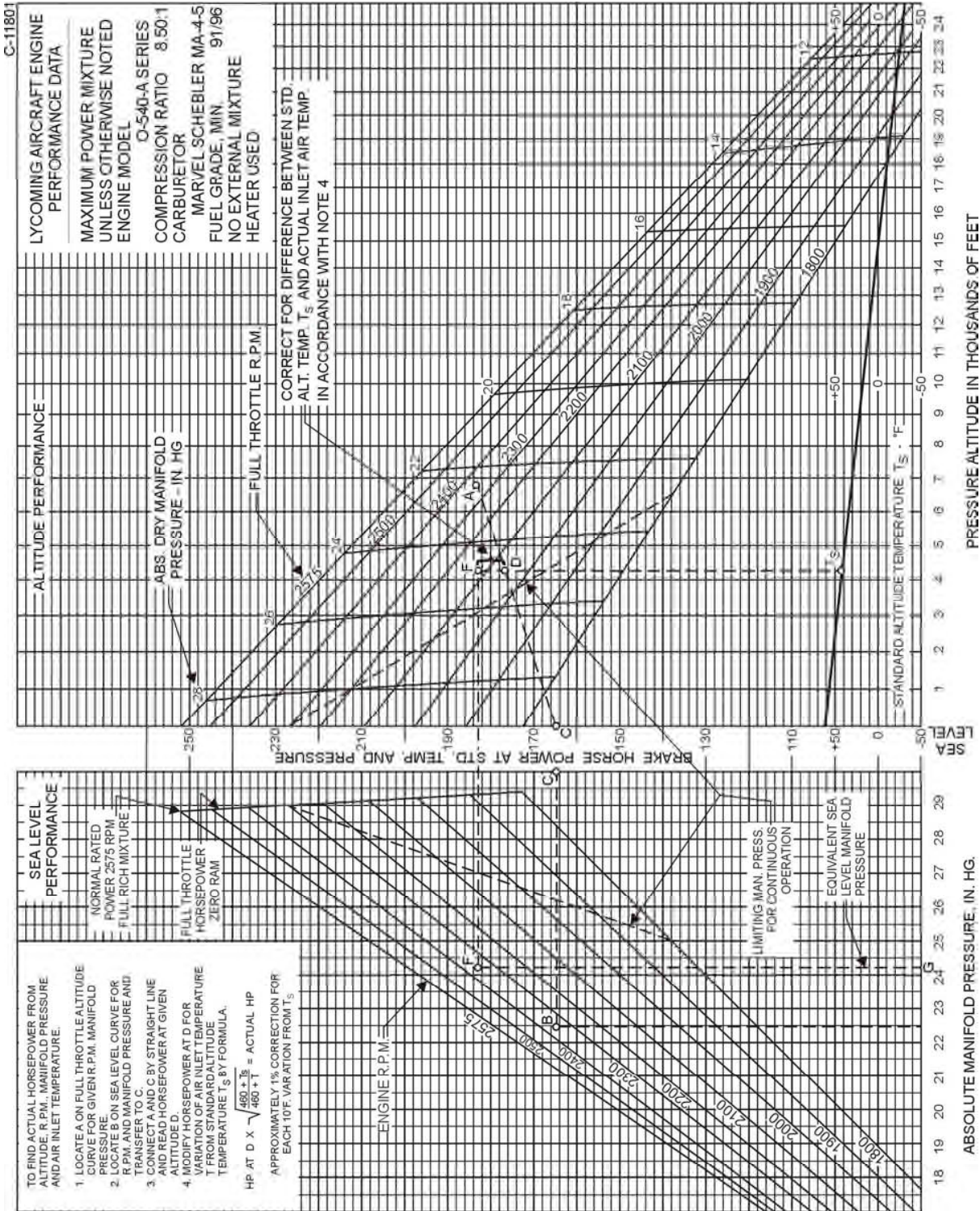

Figure 3-4. Sea Level and Altitude Performance Curve – O-540-A

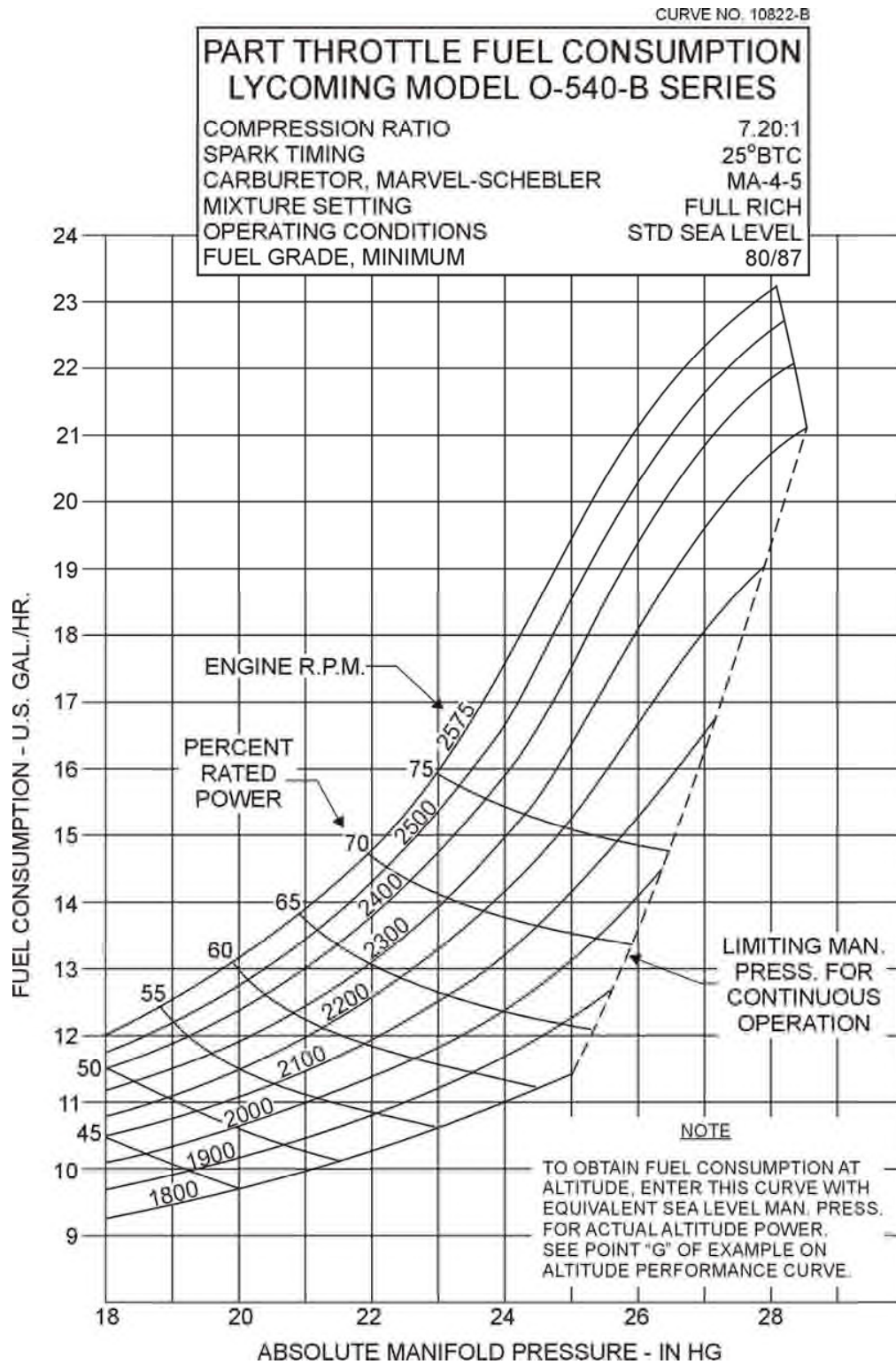

Figure 3-5. Part Throttle Fuel Consumption Curve –
O-540-B

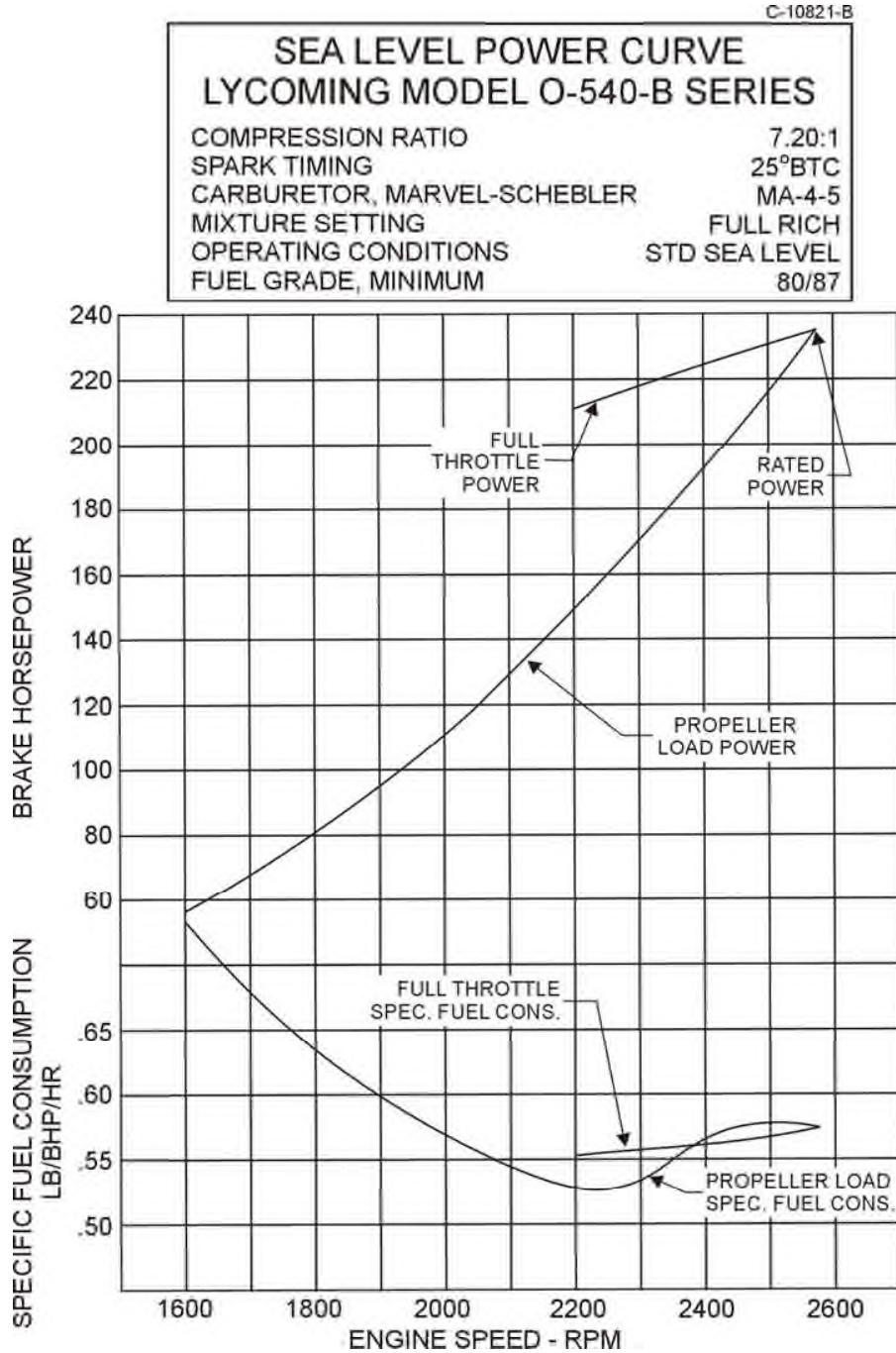

Figure 3-6. Sea Level Power Curve – O-540-B

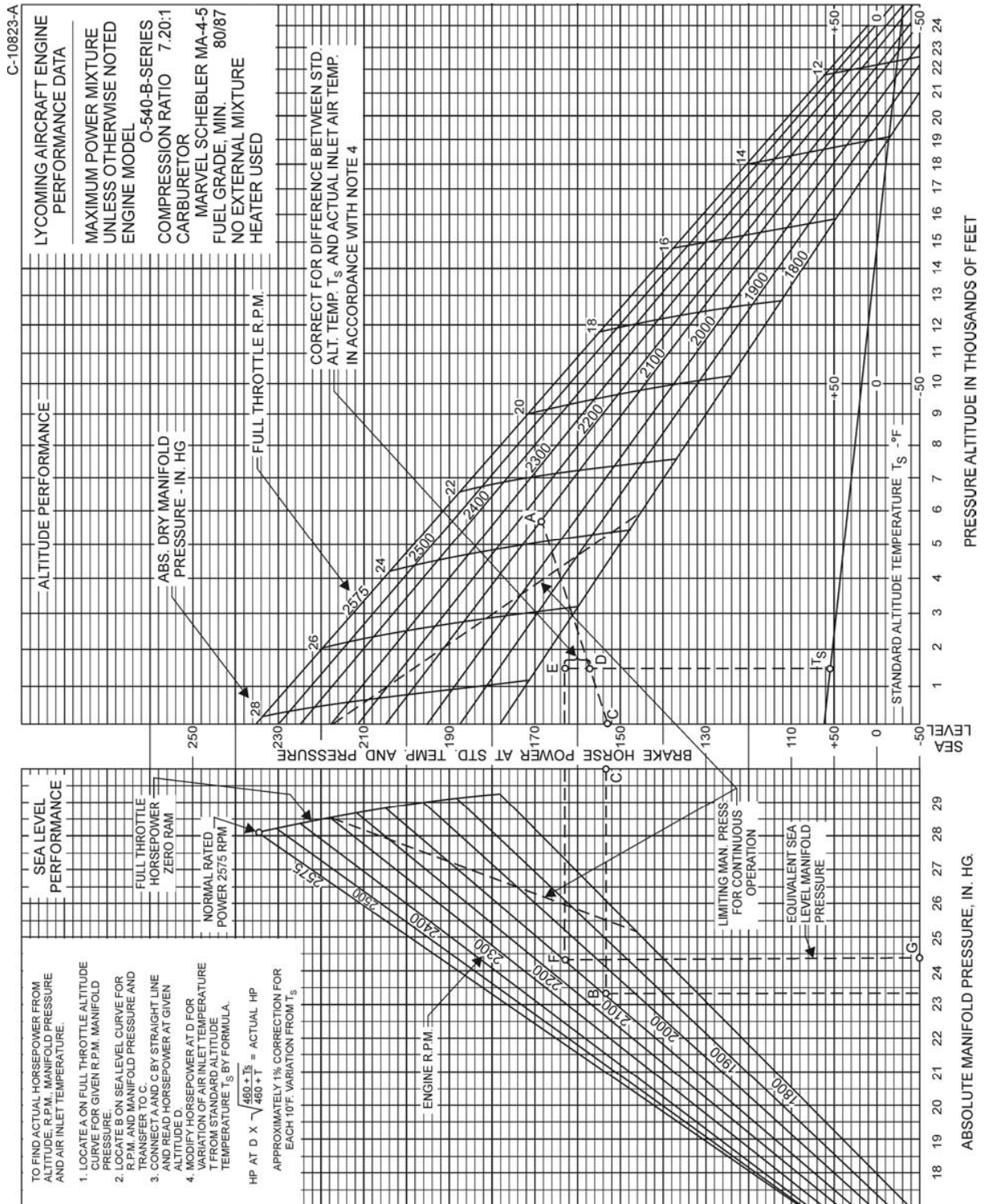

Figure 3-7. Sea Level and Altitude Performance Curve – O-540-B

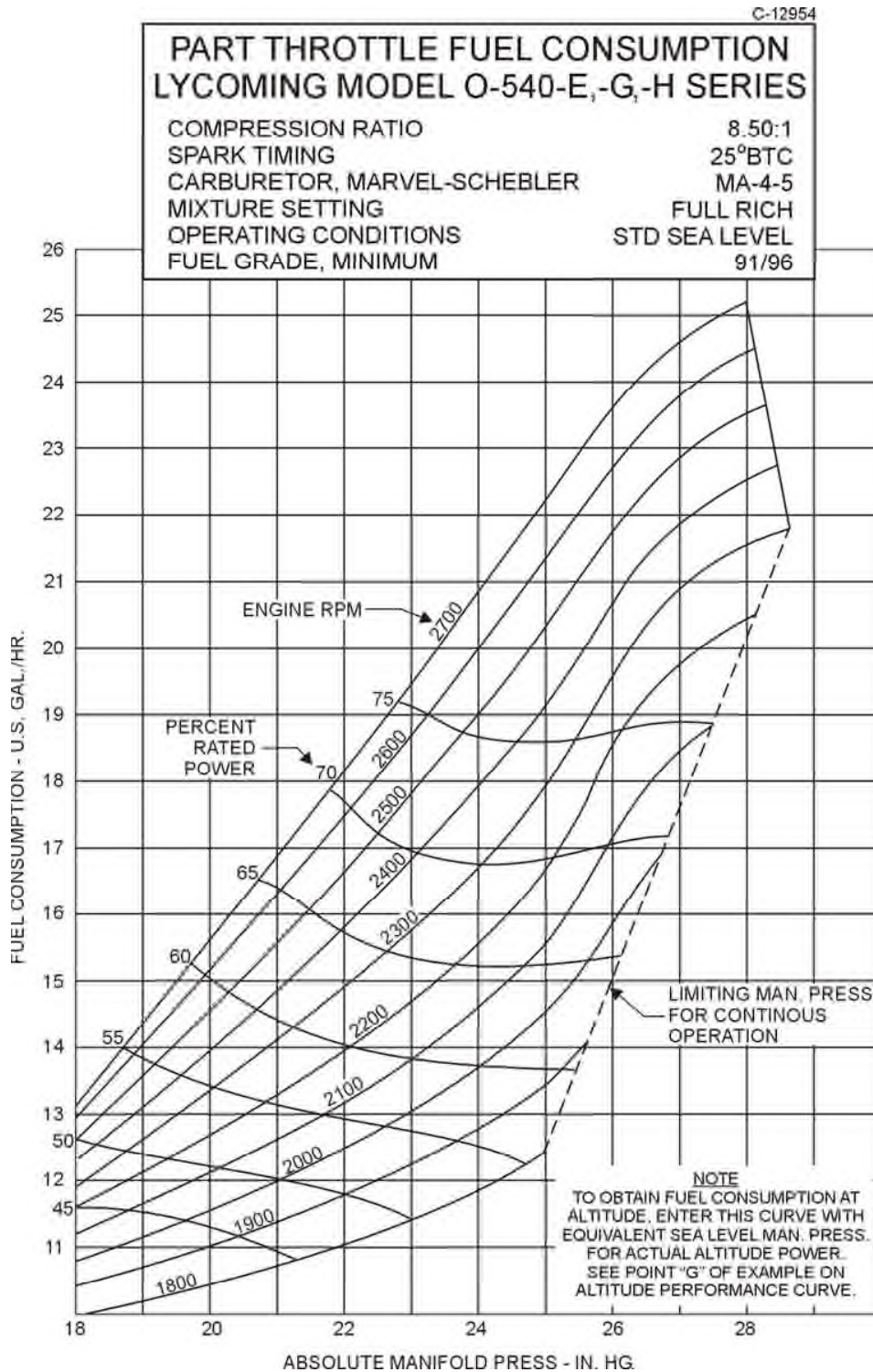

Figure 3-8. Part Throttle Fuel Consumption Curve –
O-540-E, -G, -H

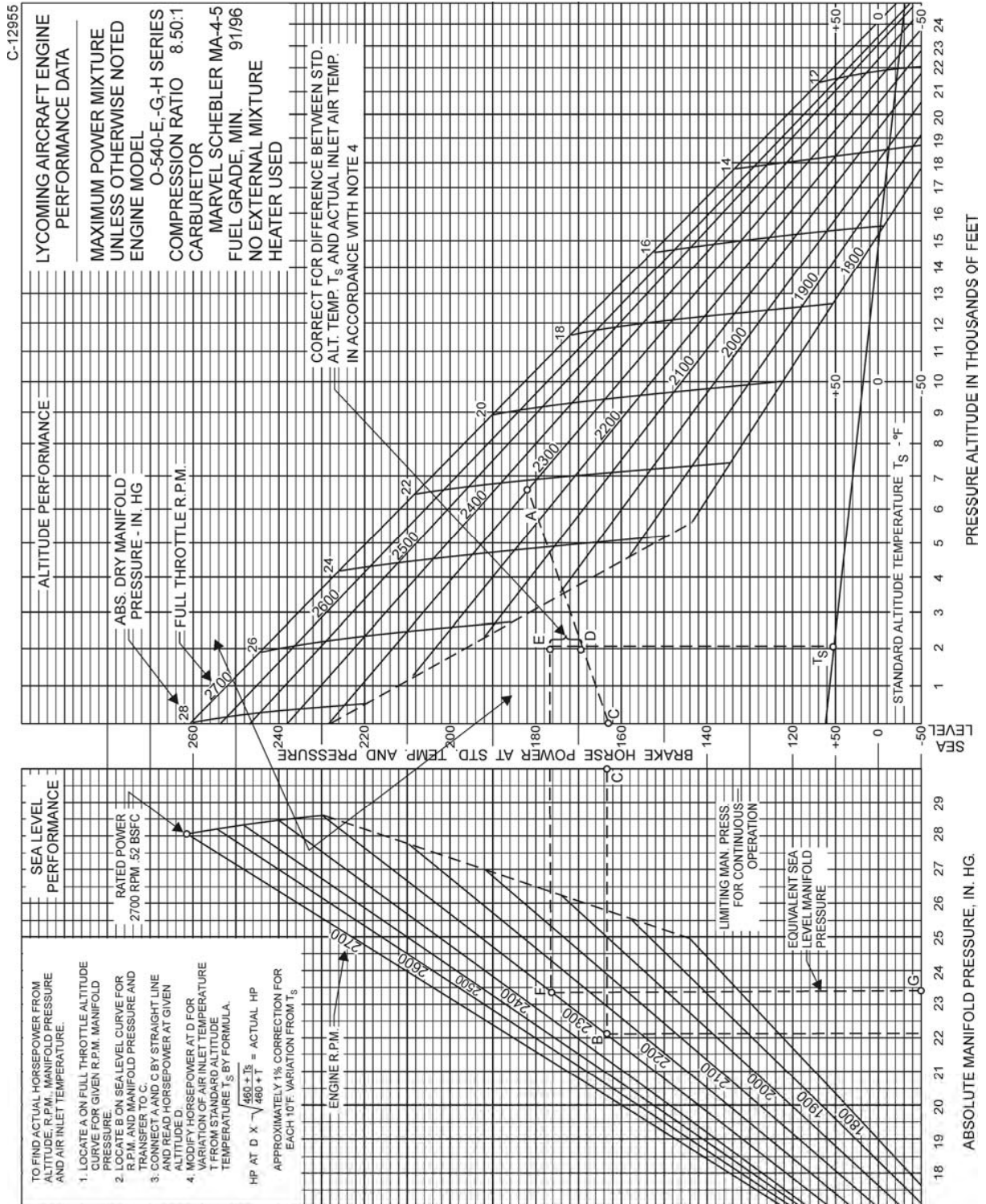

Figure 3-9. Sea Level and Altitude Performance Curve – O-540-E, -G, -H

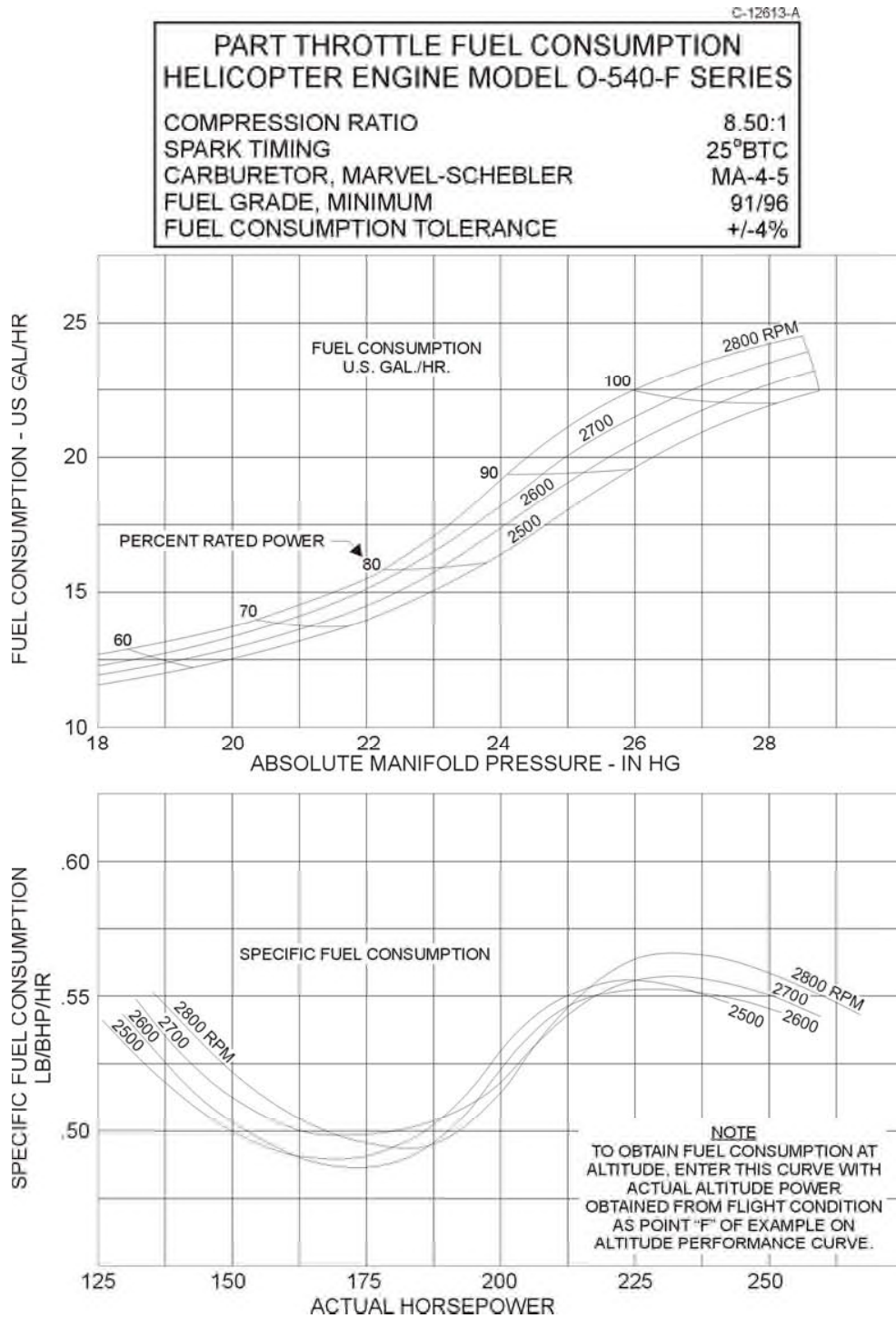

Figure 3-10. Part Throttle Fuel Consumption Curve –
O-540-F Series

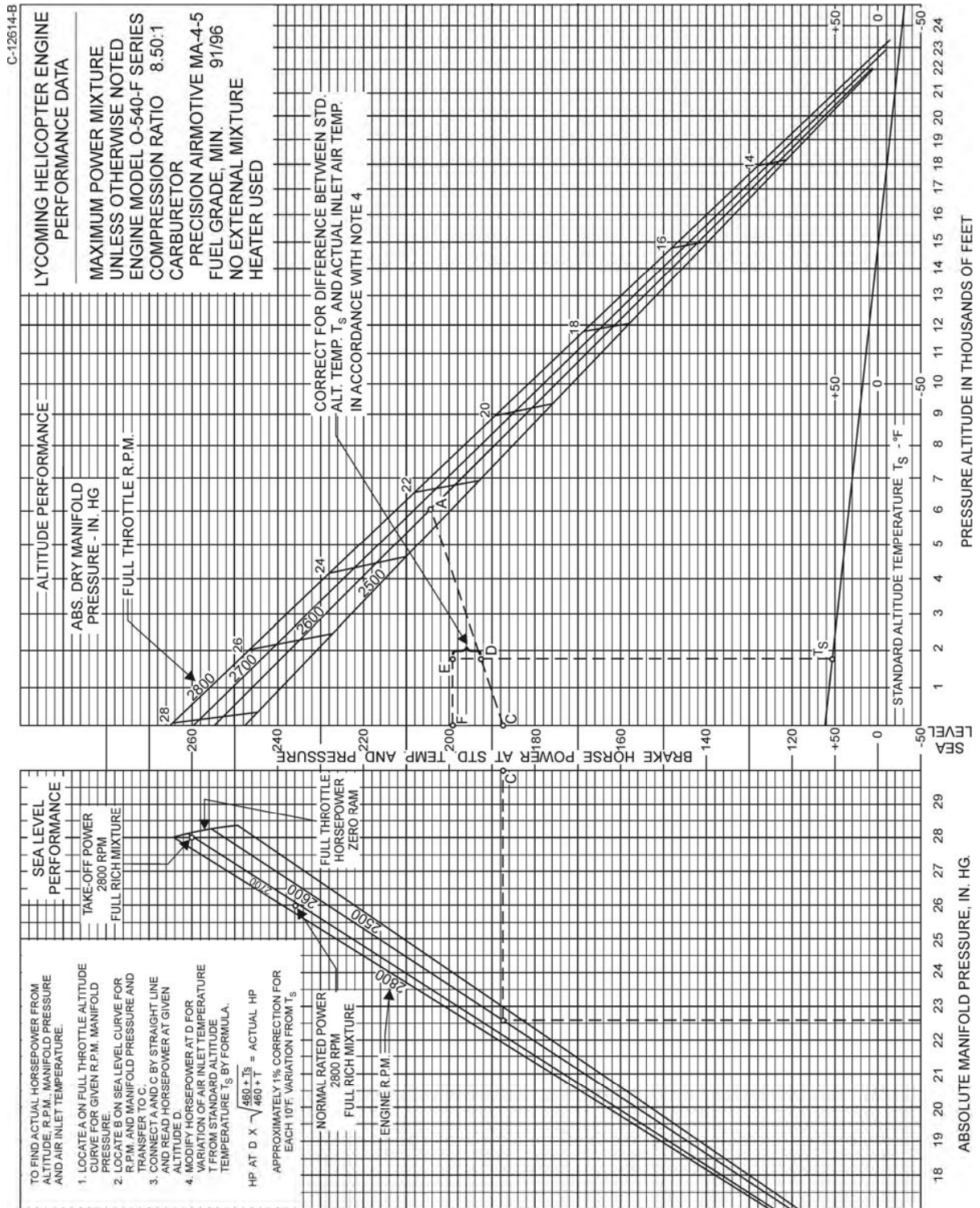

Figure 3-11. Sea Level and Altitude Performance Curve – O-540-F Series

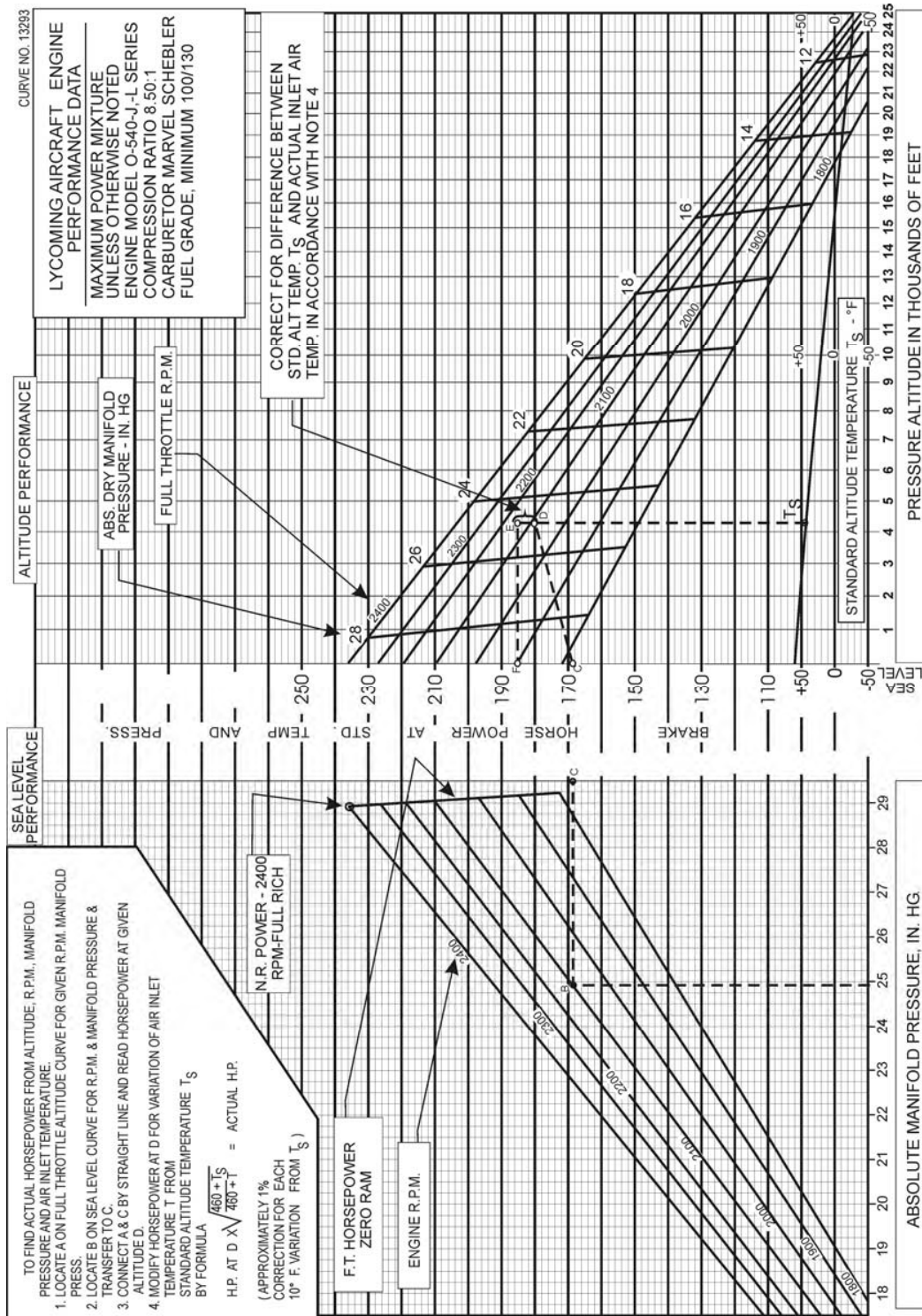

Figure 3-12. Sea Level and Altitude Performance Curve – O-540-J, -L

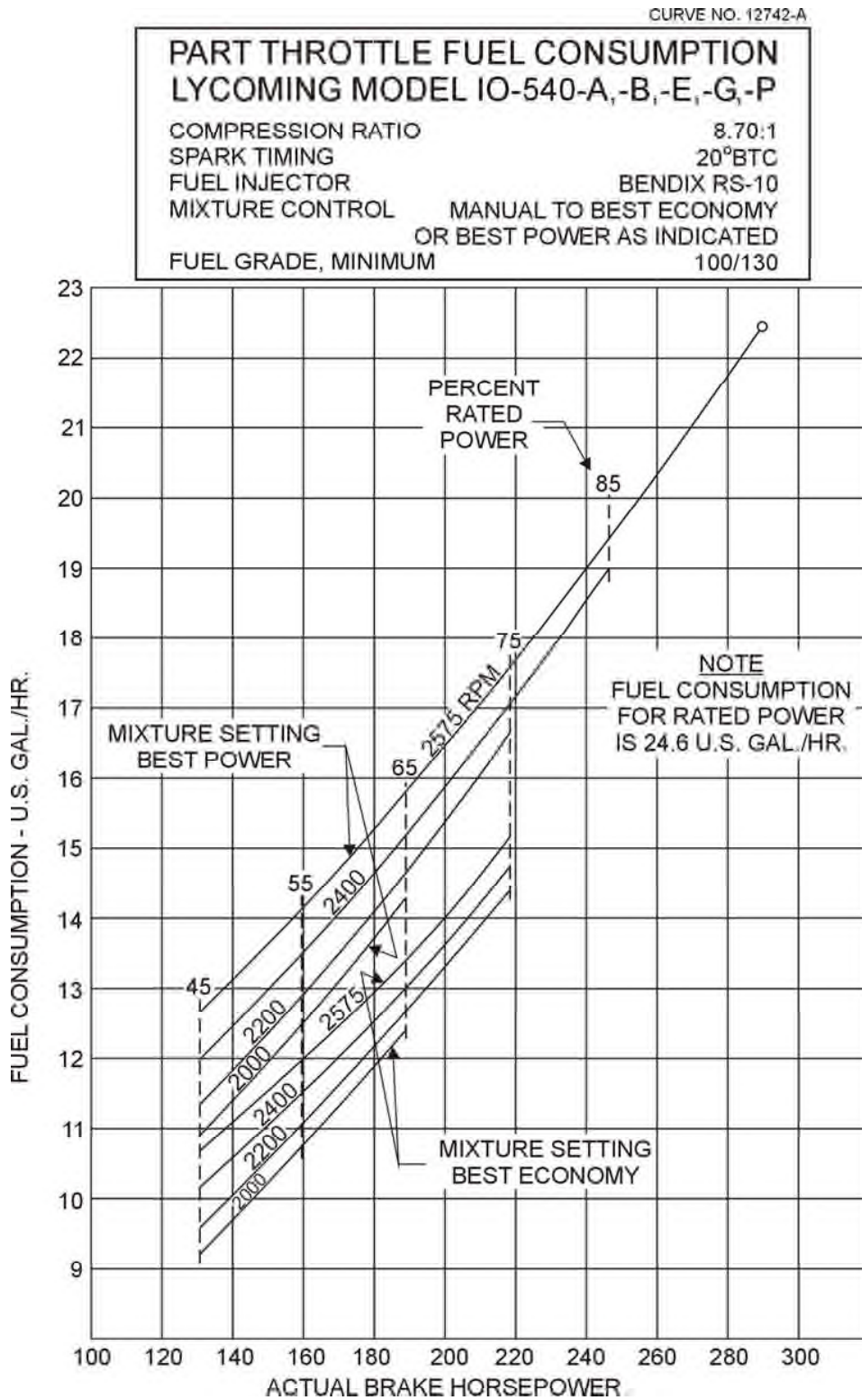

Figure 3-13. Part Throttle Fuel Consumption –
IO-540-A, -B, -E, -G, -P

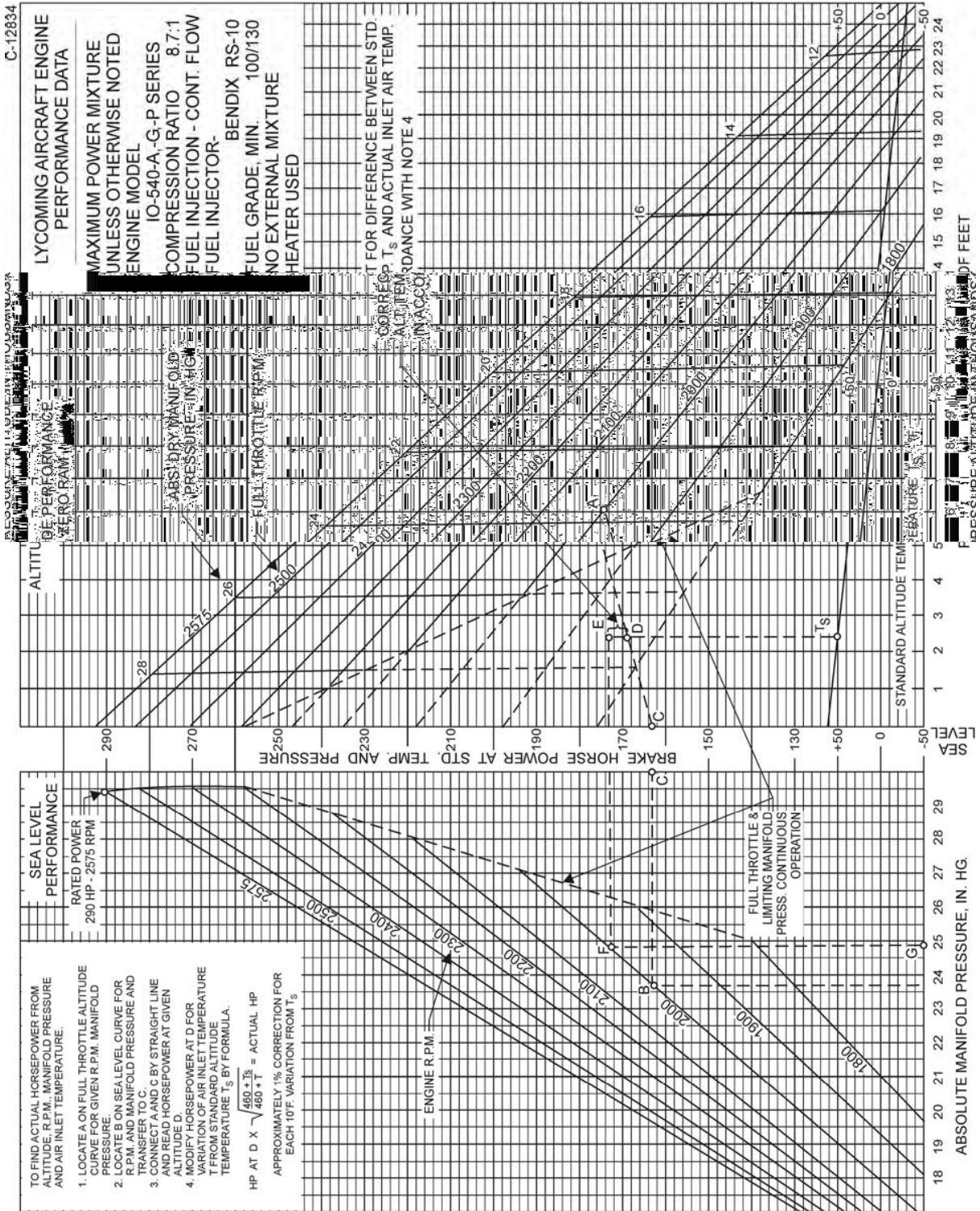

Figure 3-14. Sea Level and Altitude Performance Curve – IO-540-A, -G, -P

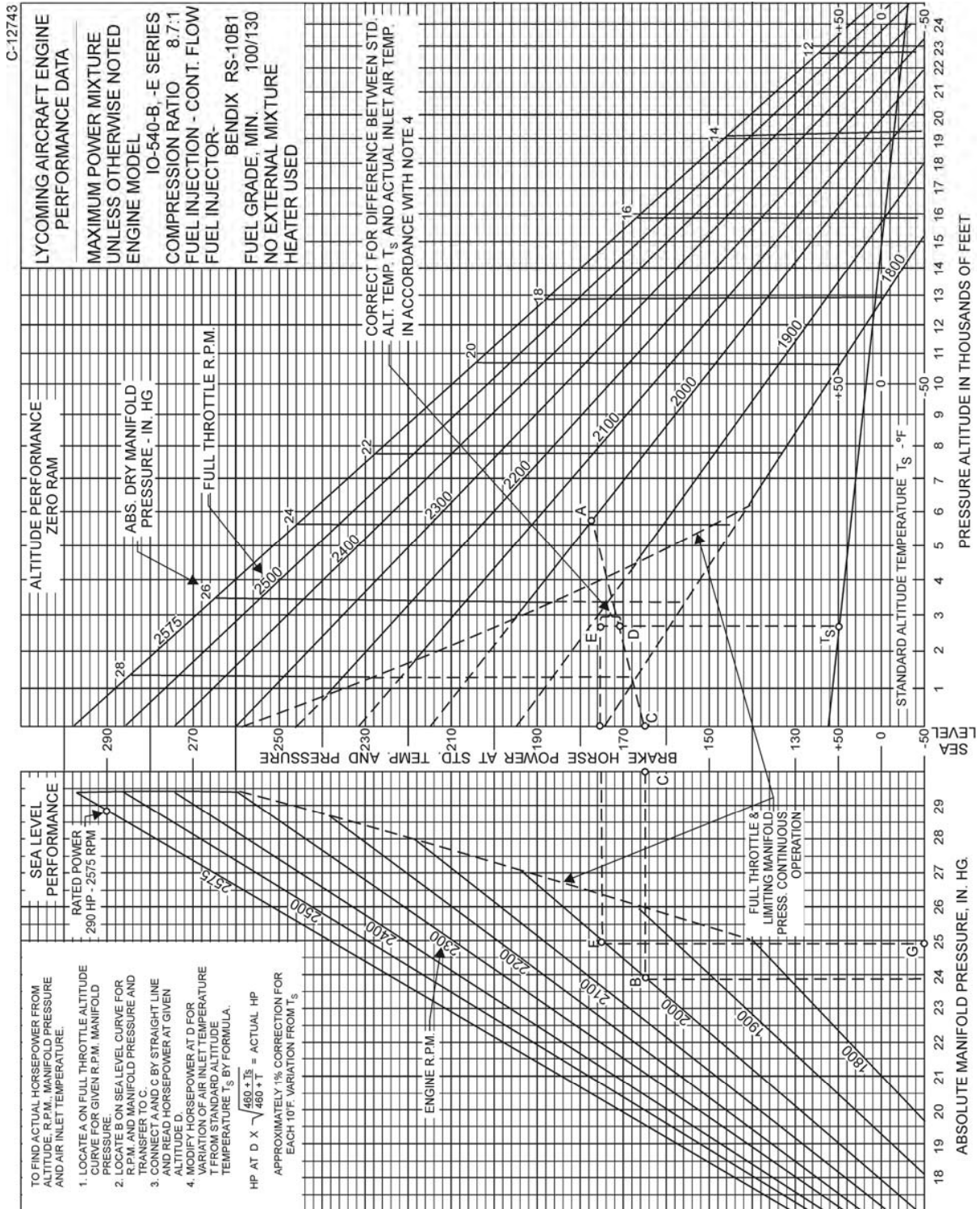

Figure 3-15. Sea Level and Altitude Performance Curve – IO-540-B, -E

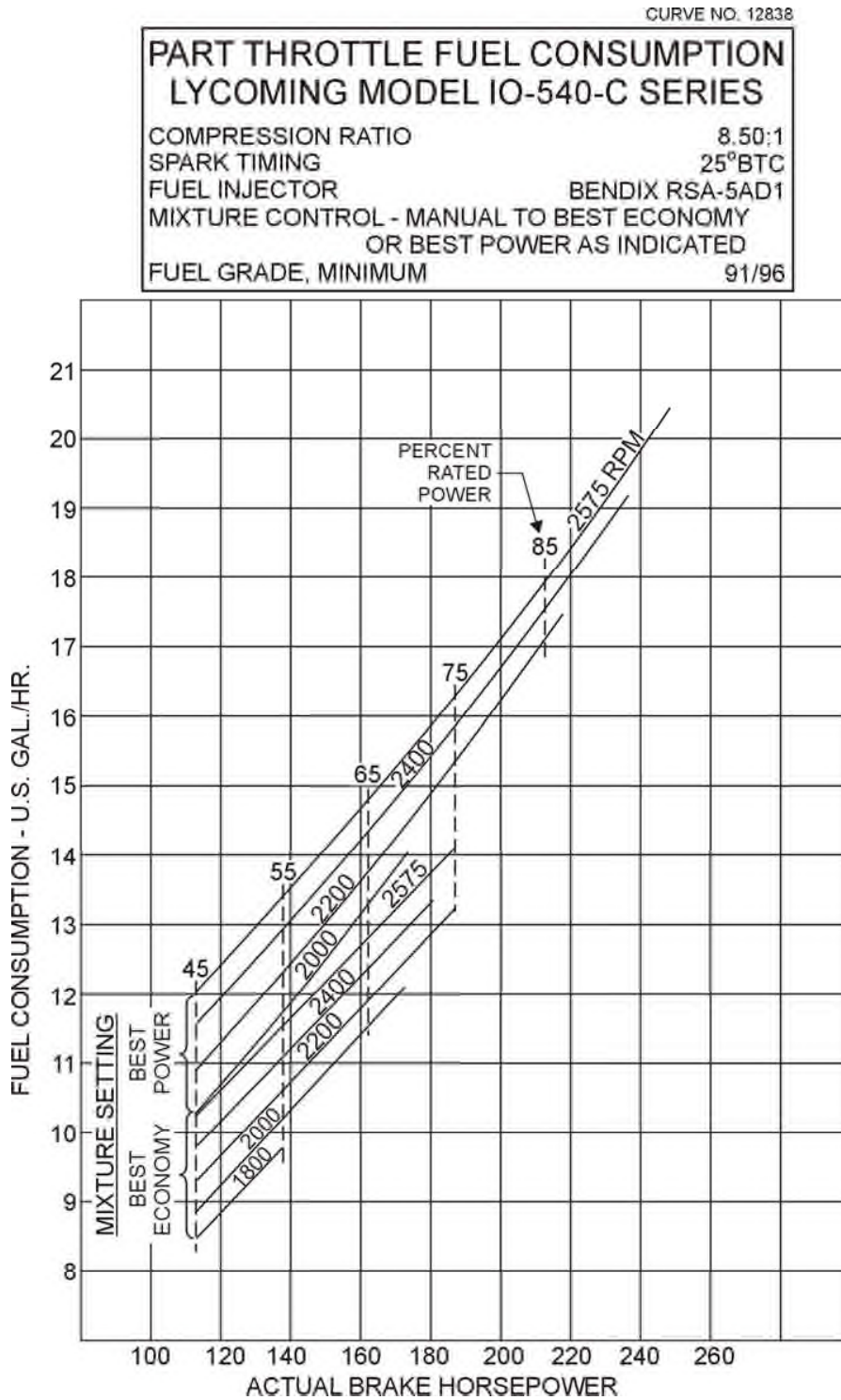

Figure 3-16. Part Throttle Fuel Consumption Curve – IO-540-C

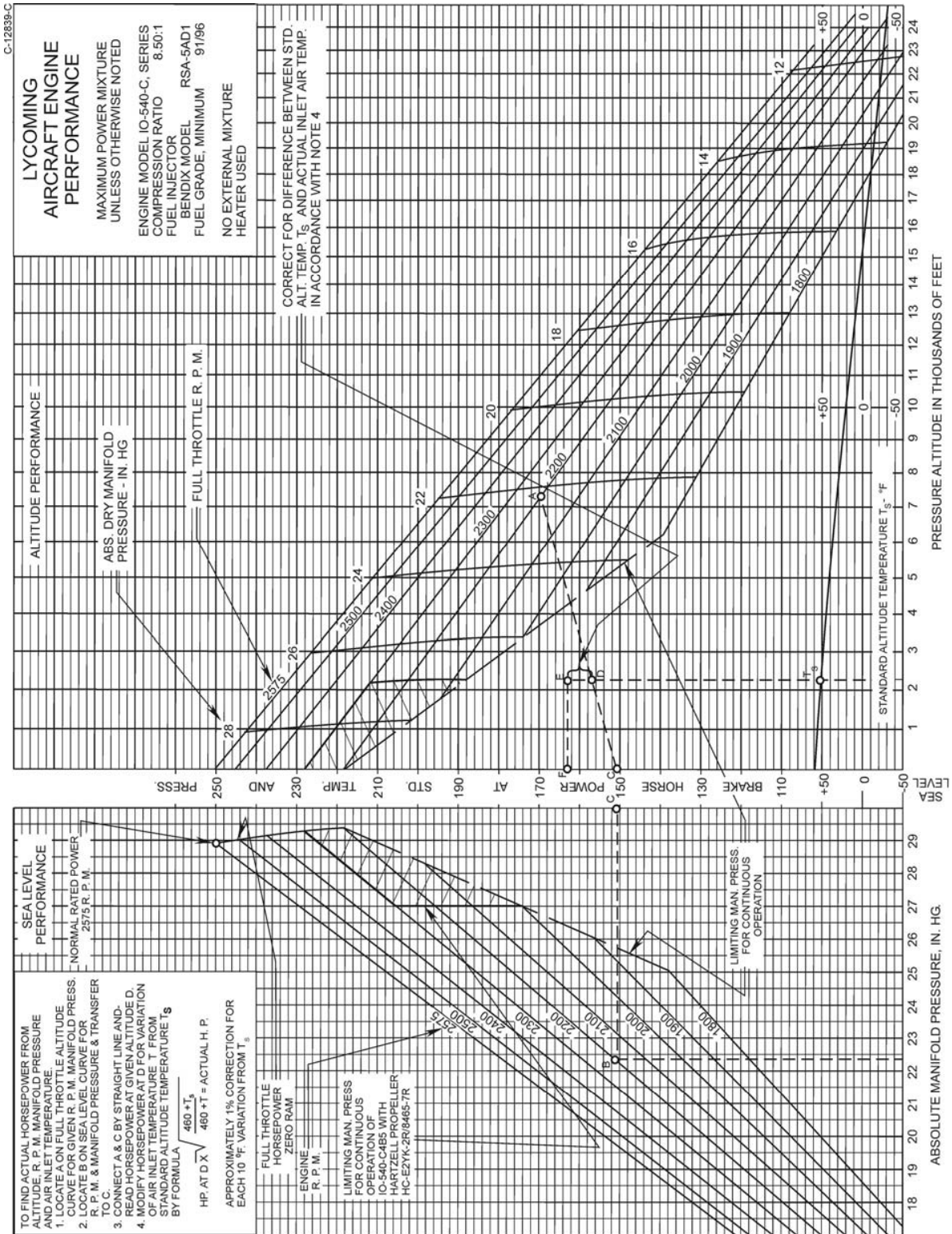

Figure 3-17. Sea Level and Altitude Performance Curve – IO-540-C

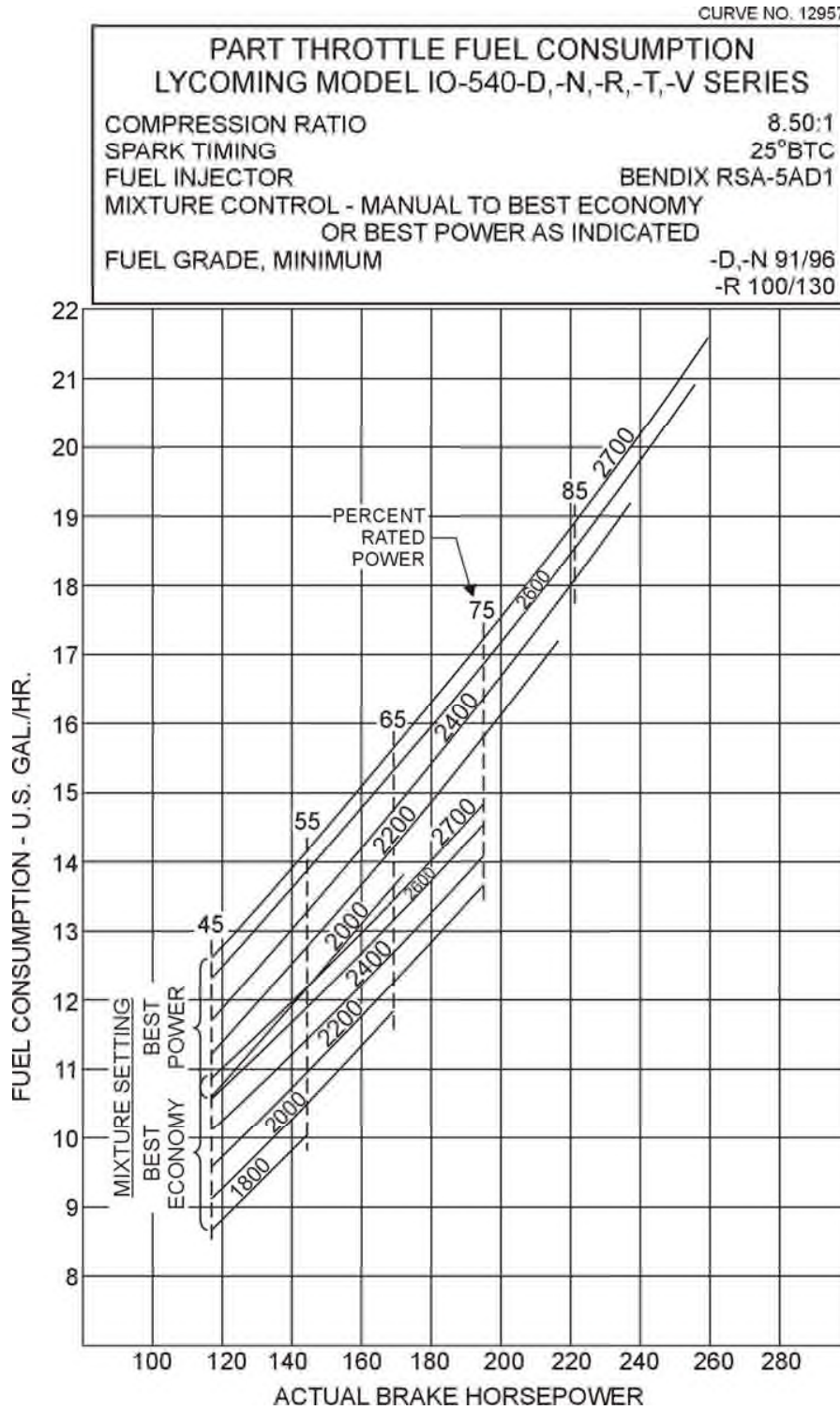

Figure 3-18. Part Throttle Fuel Consumption Curve –
IO-540-D, -N, -R, -T, -V

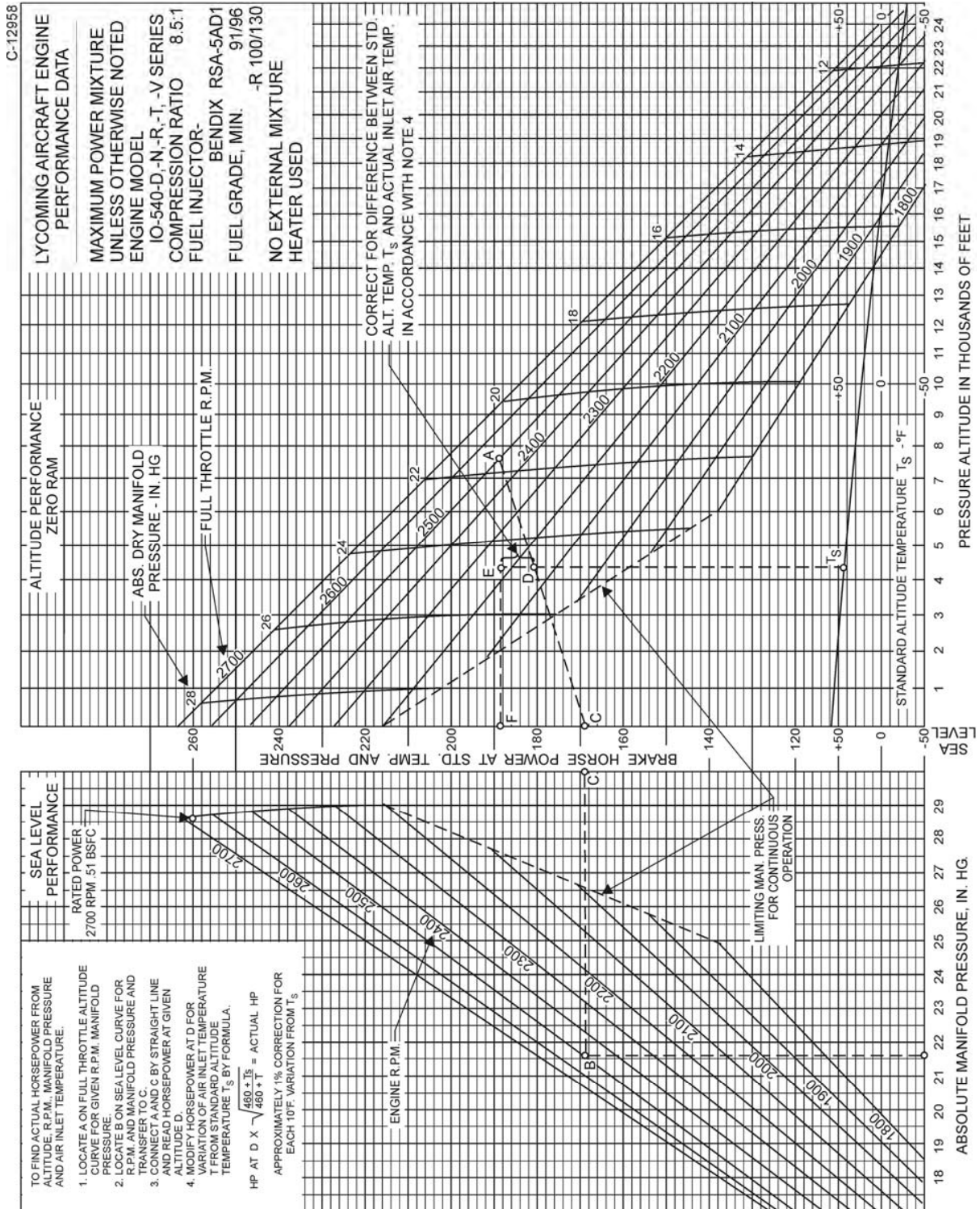

Figure 3-19. Sea Level and Altitude Performance Curve – IO-540-D, -N, -R, -T, -V

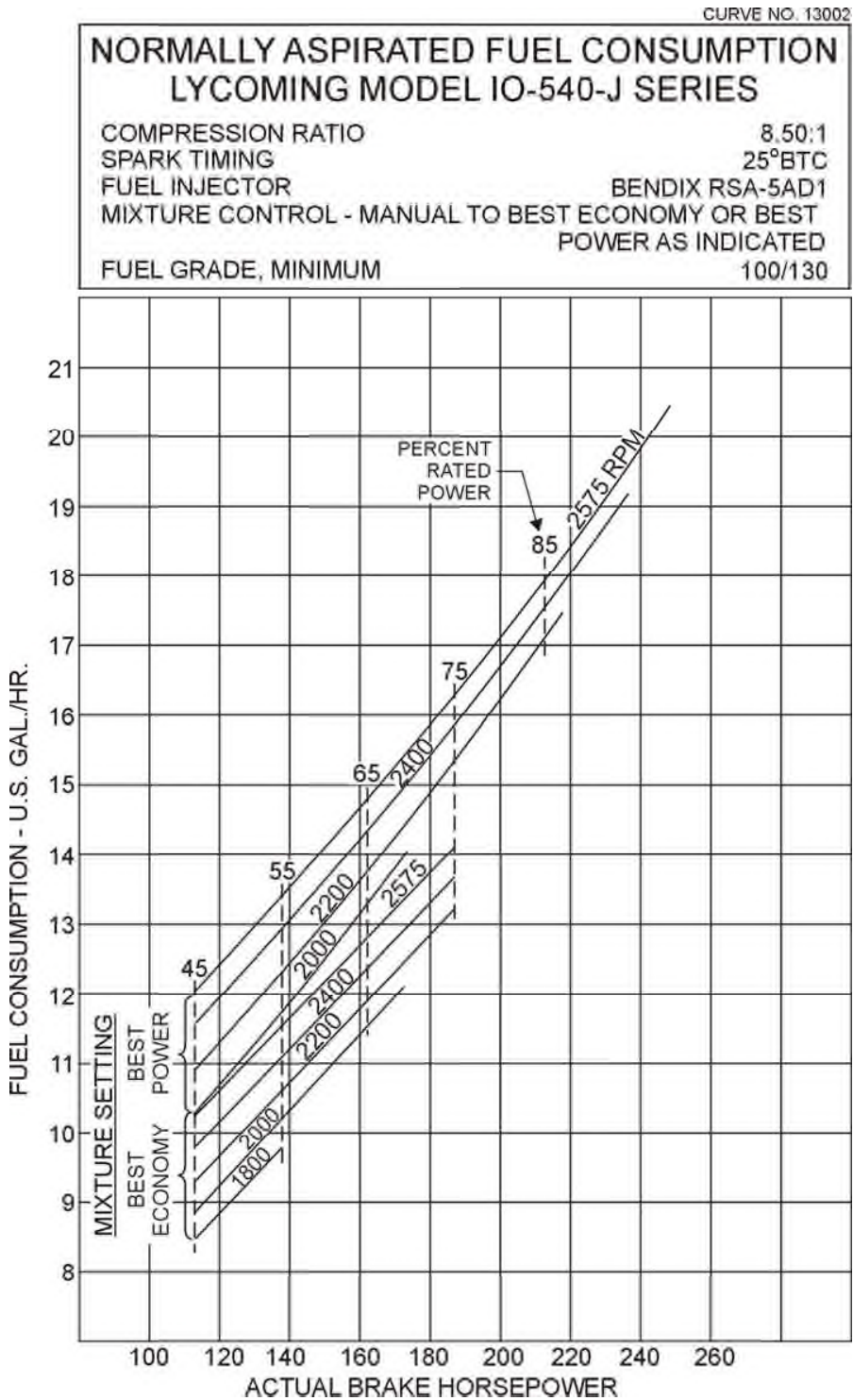

Figure 3-20. Normally Aspirated Fuel Consumption Curve – IO-540-J

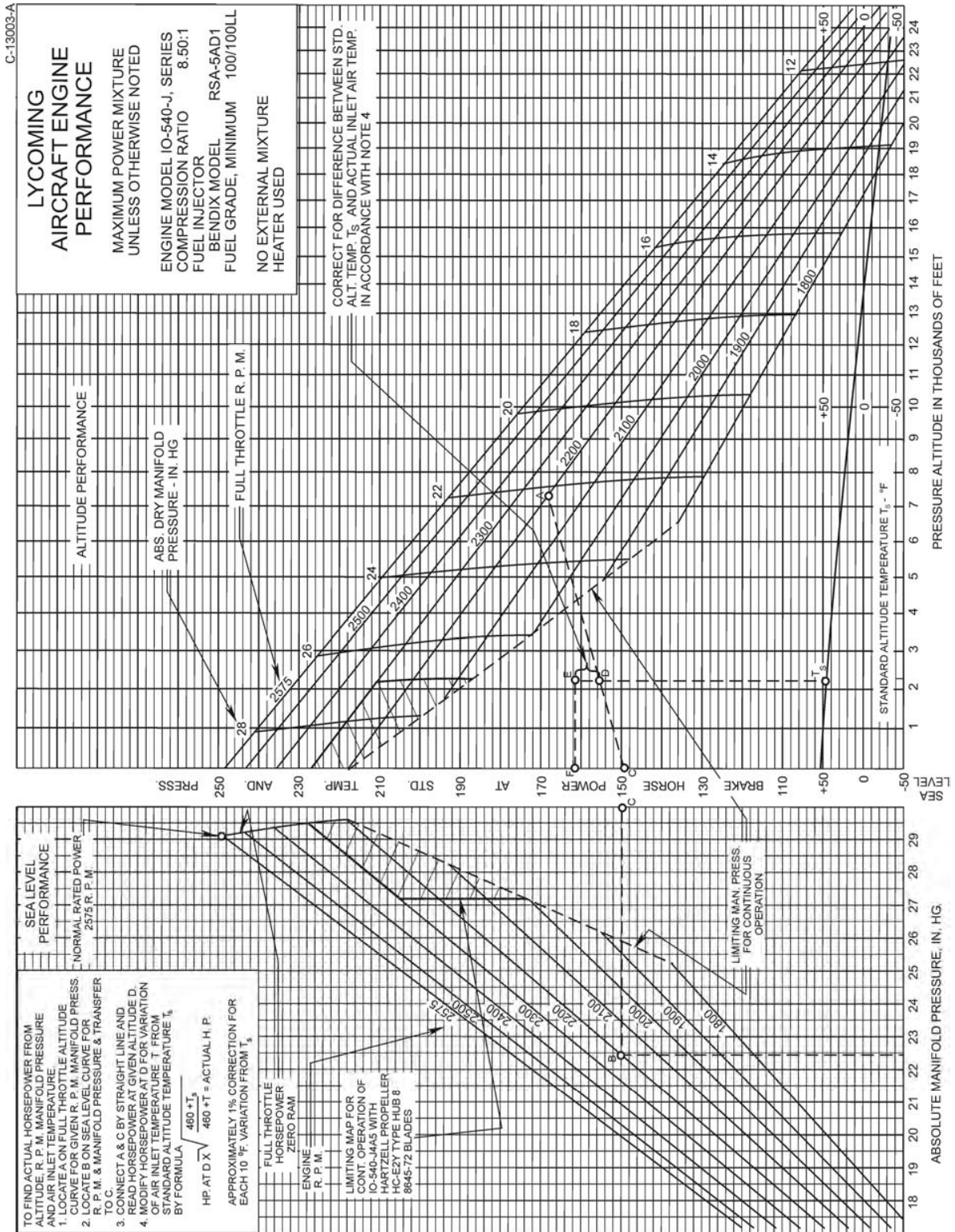

Figure 3-21. Sea Level and Altitude Performance Curve – IO-540-J

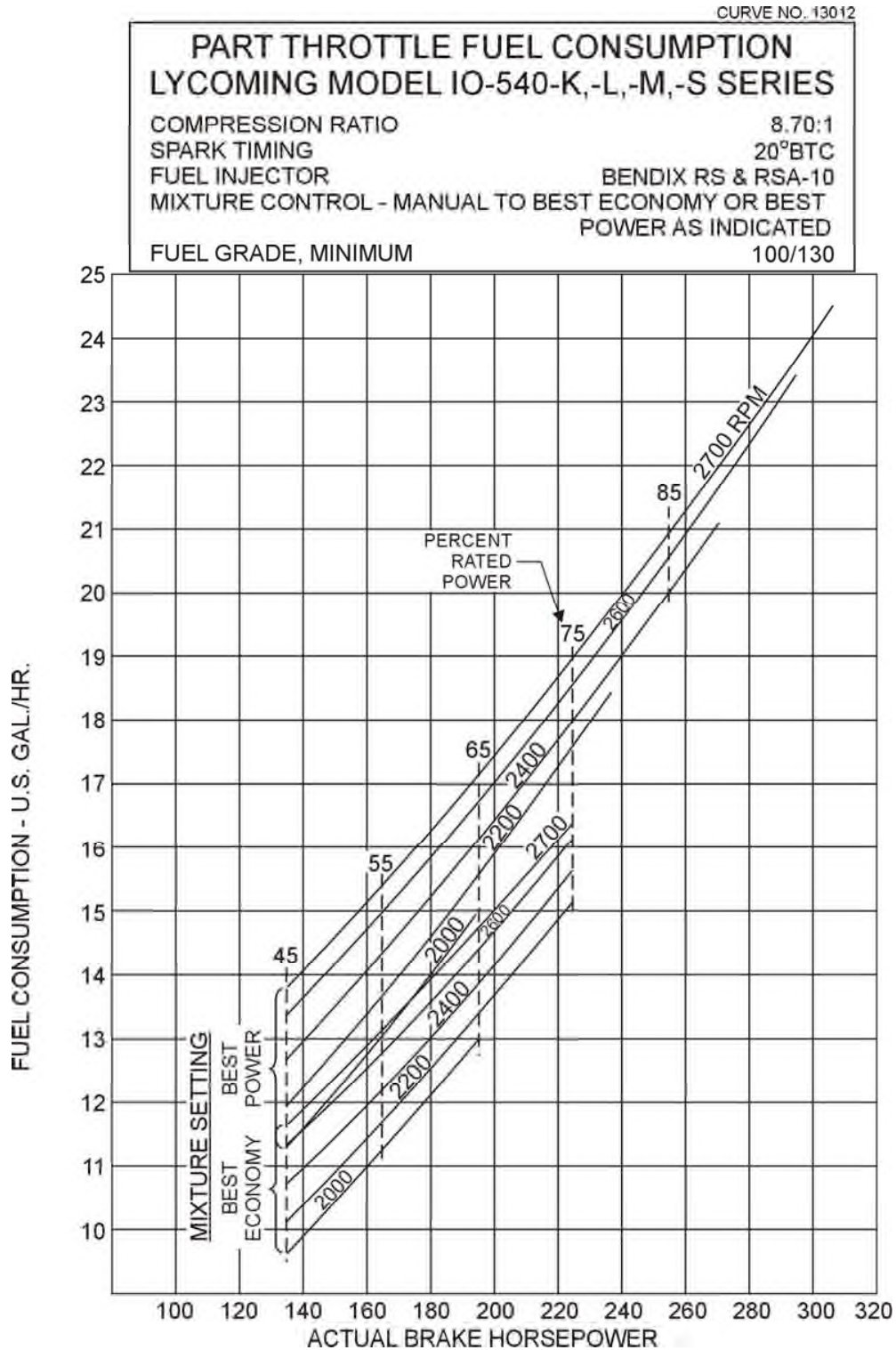

Figure 3-22. Part Throttle Fuel Consumption Curve –
IO-540-K, -L, -M, -S

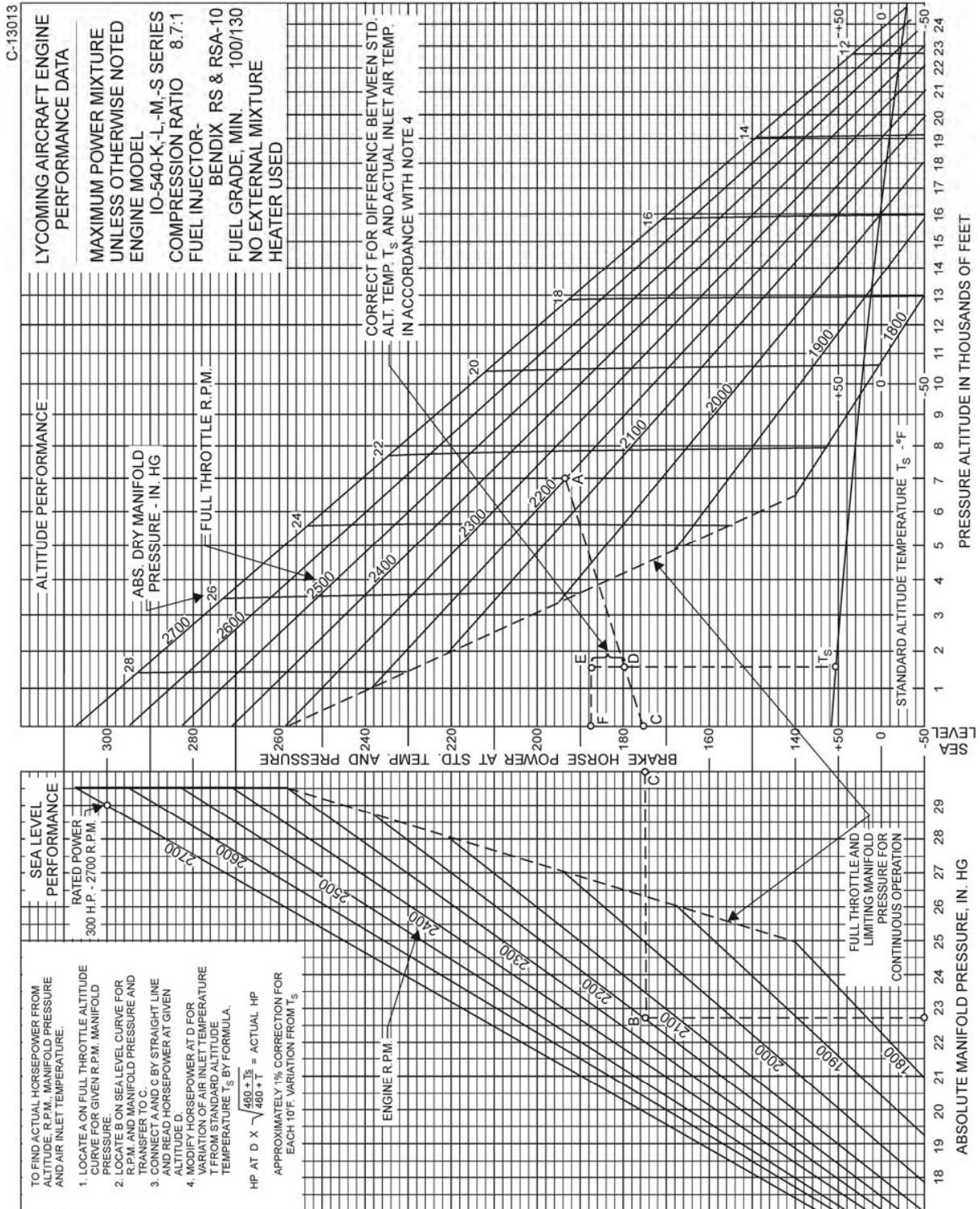

Figure 3-23. Sea Level and Altitude Performance Curve – IO-540-K, -L, -M, -S

FUEL FLOW vs PERCENT RATED POWER
LYCOMING IO-540-W SERIES

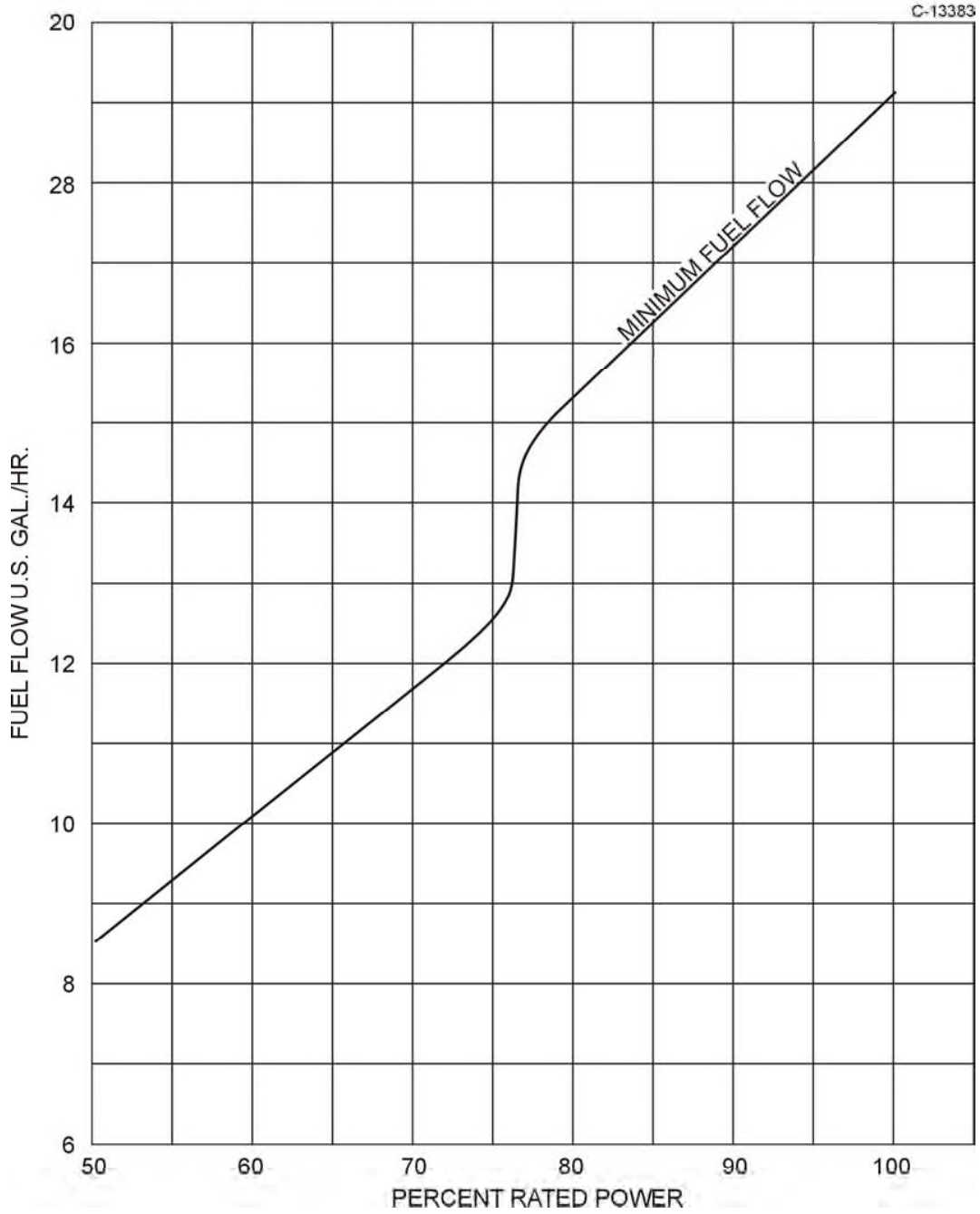

Figure 3-24. Fuel Flow vs Percent Rated Power Curve –
IO-540-W Series

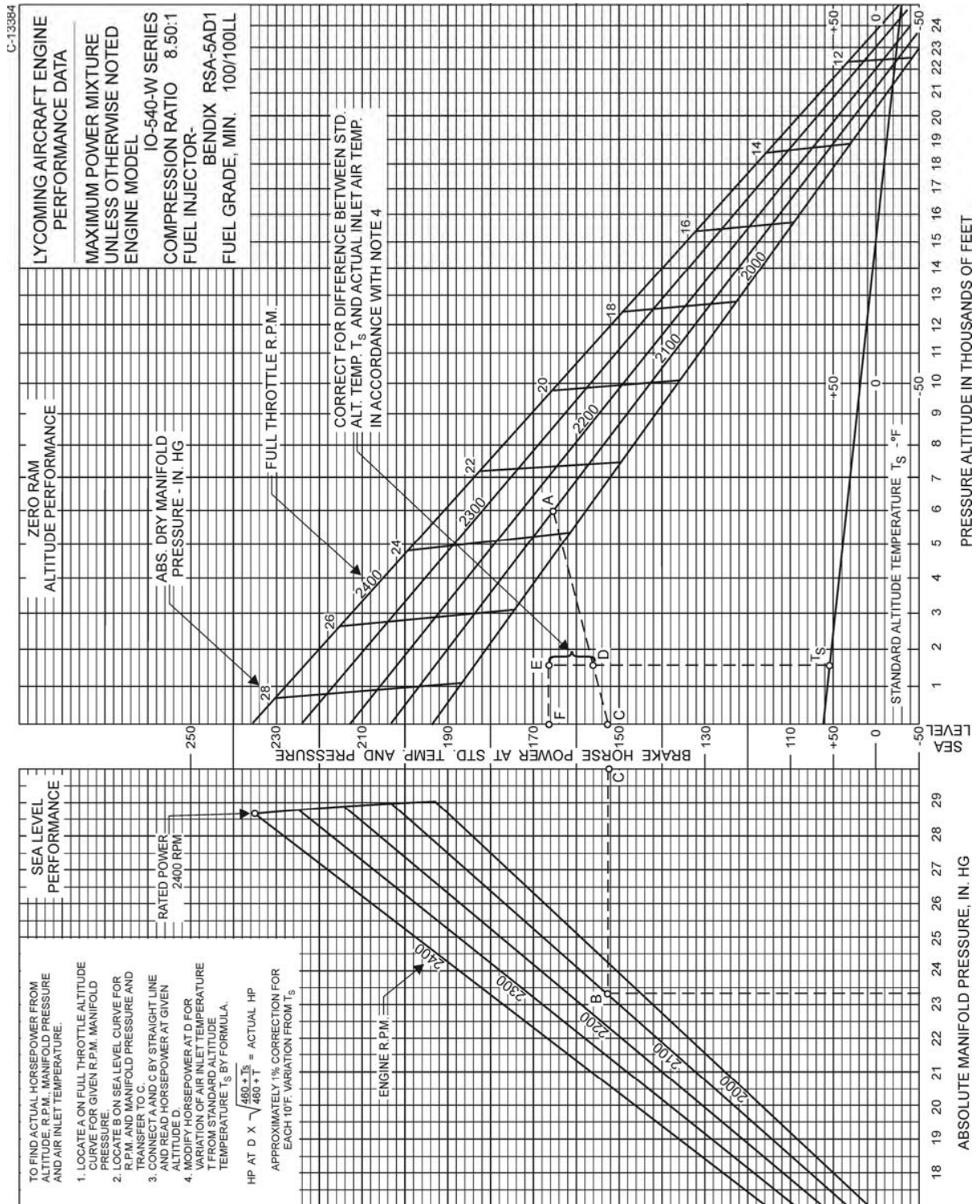

Figure 3-25. Sea Level and Altitude Performance Curve – IO-540-W Series

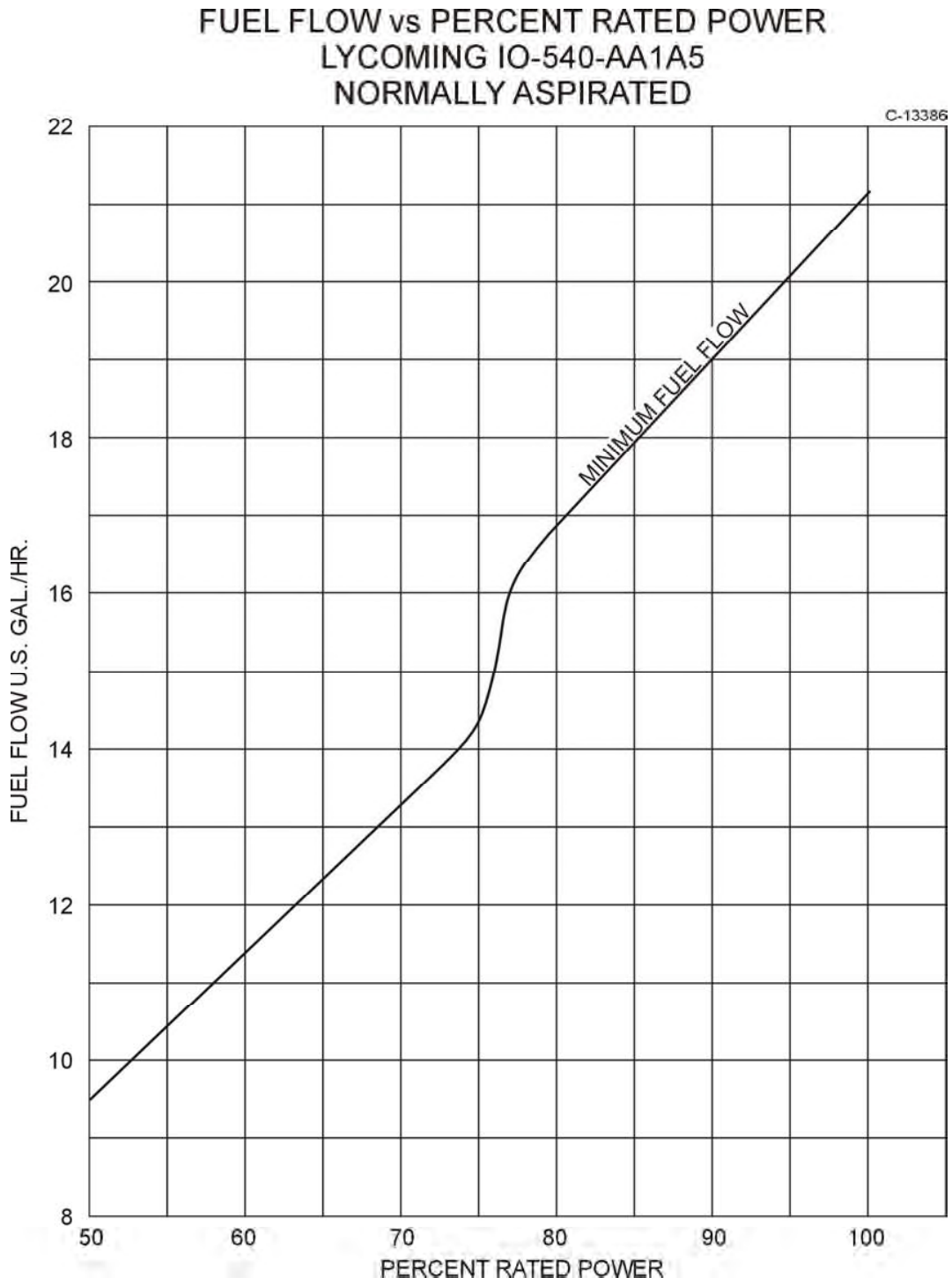

Figure 3-26. Fuel Flow vs Percent Rated Power –
IO-540-AA1A5

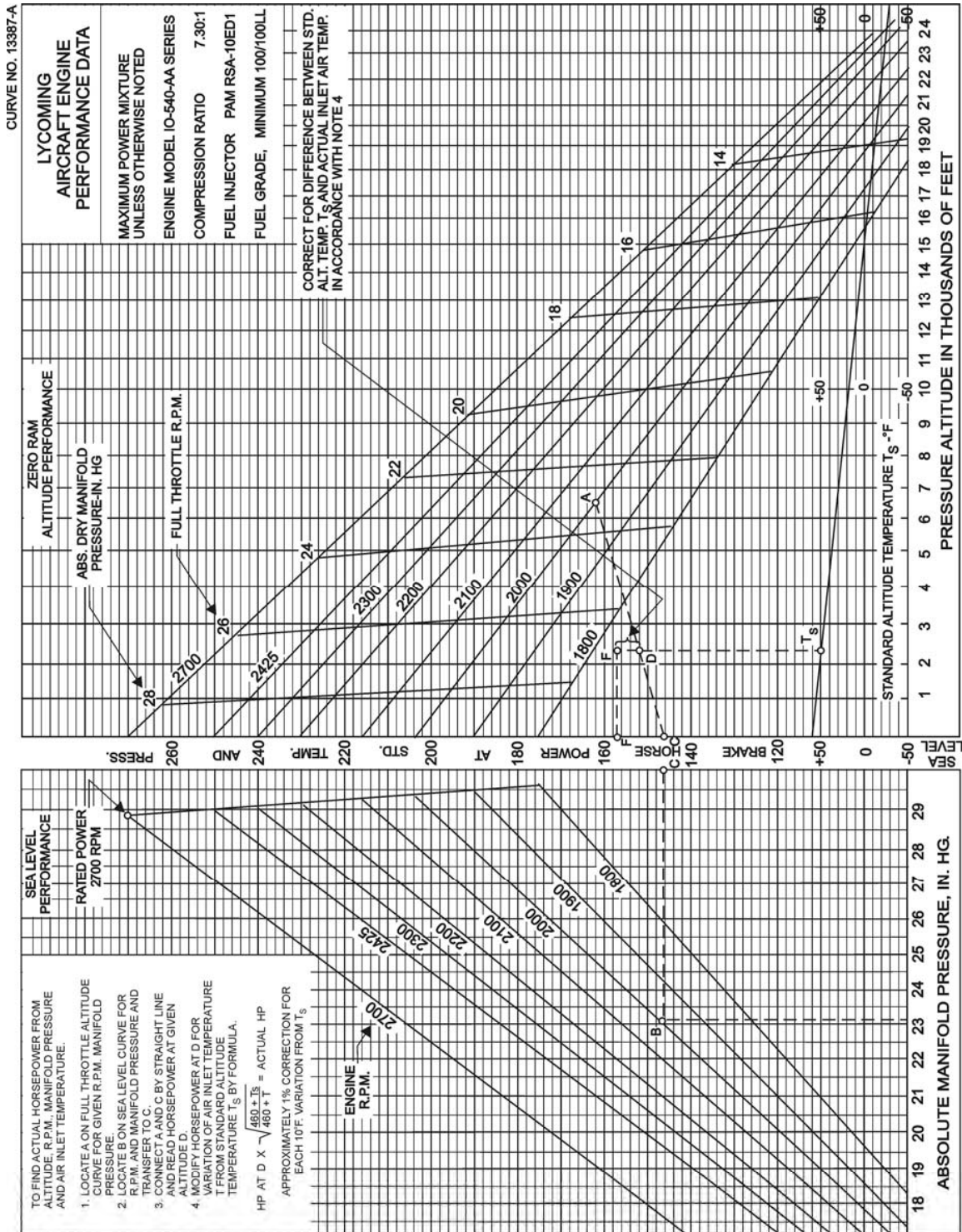

Figure 3-27. Sea Level and Altitude Performance Curve – IO-540-AA1A5

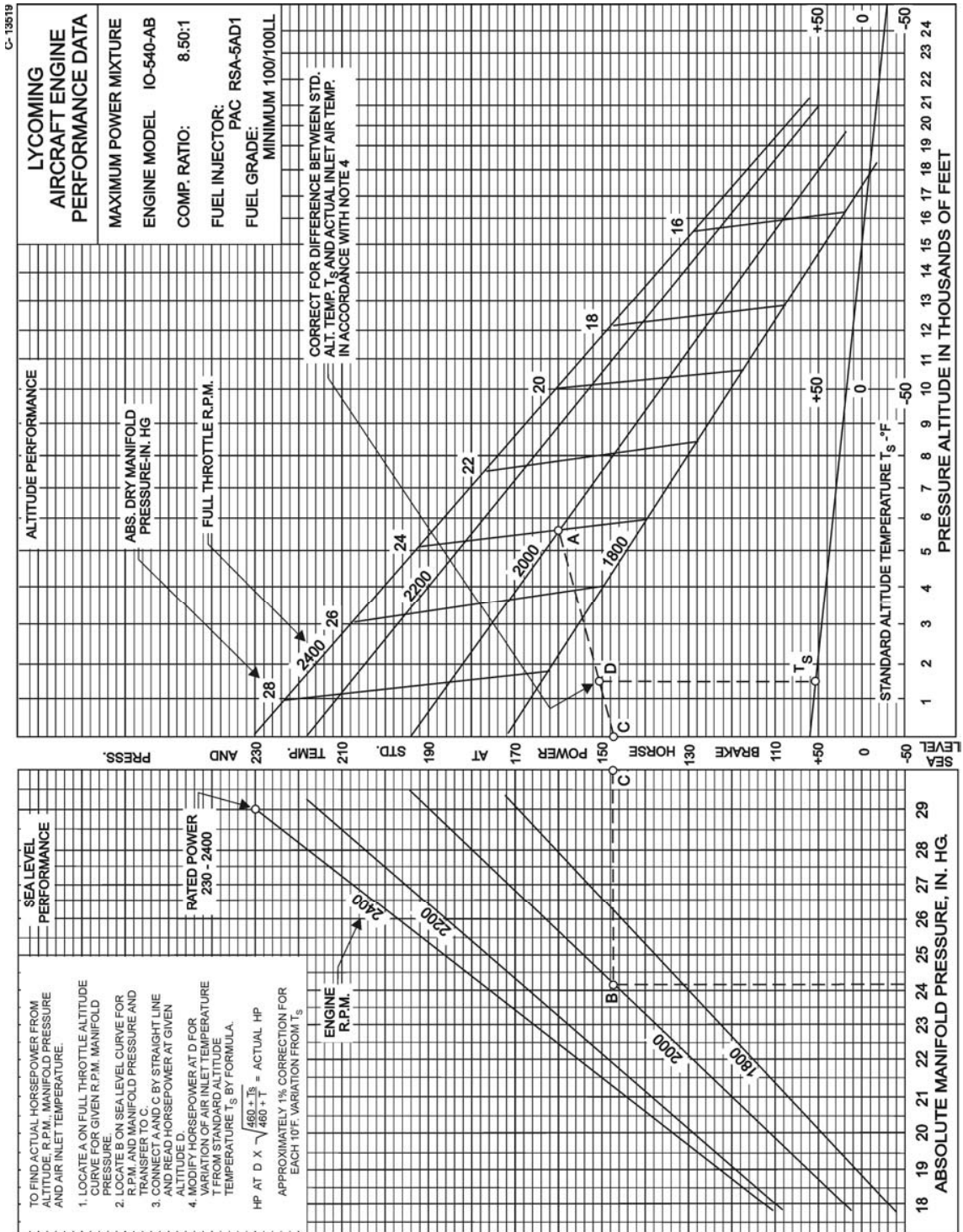

Figure 3-28. Sea Level and Altitude Performance Curve – IO-540-AB Series

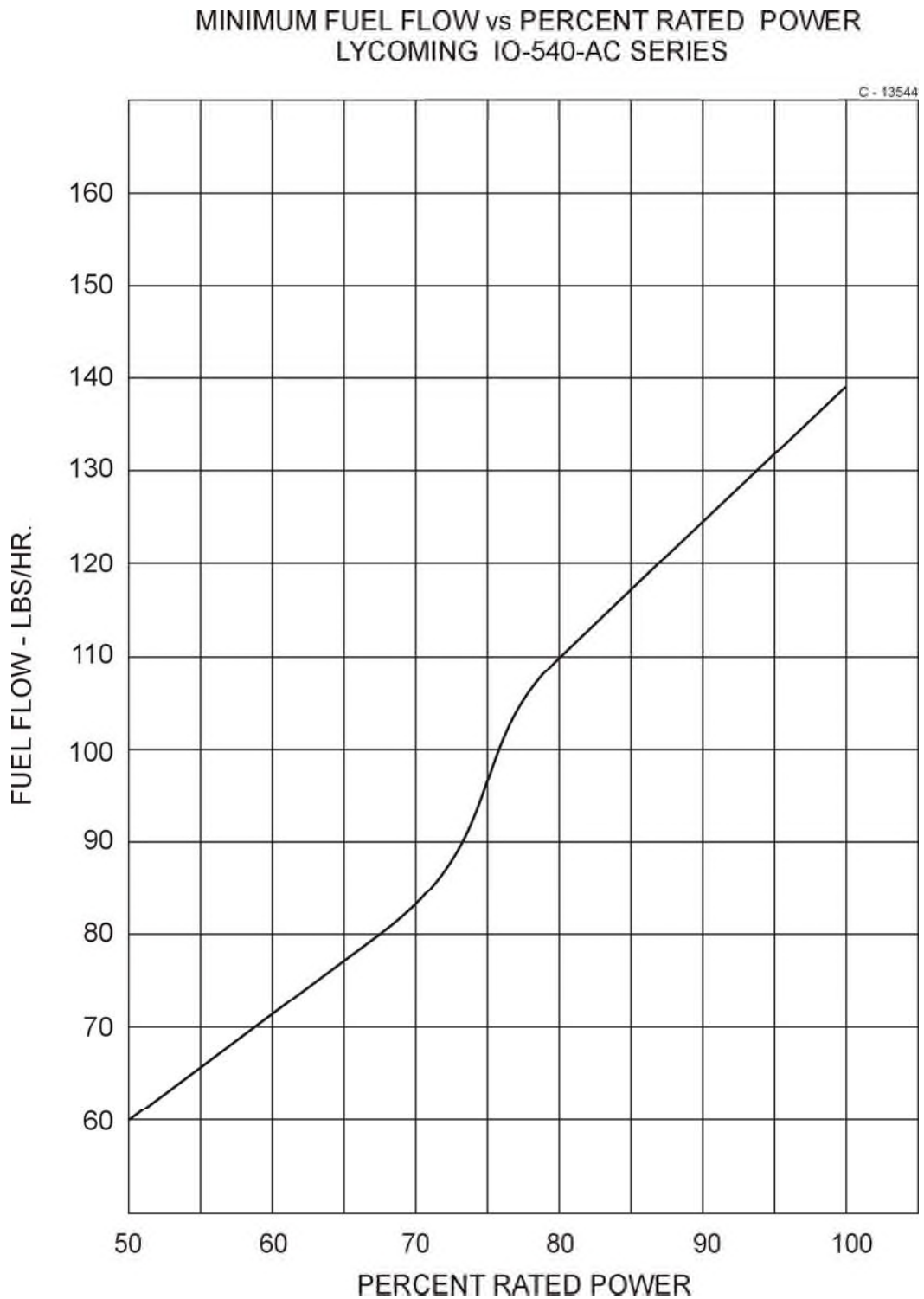

Figure 3-29. Fuel Flow vs Percent Rated Power –
IO-540-AC Series

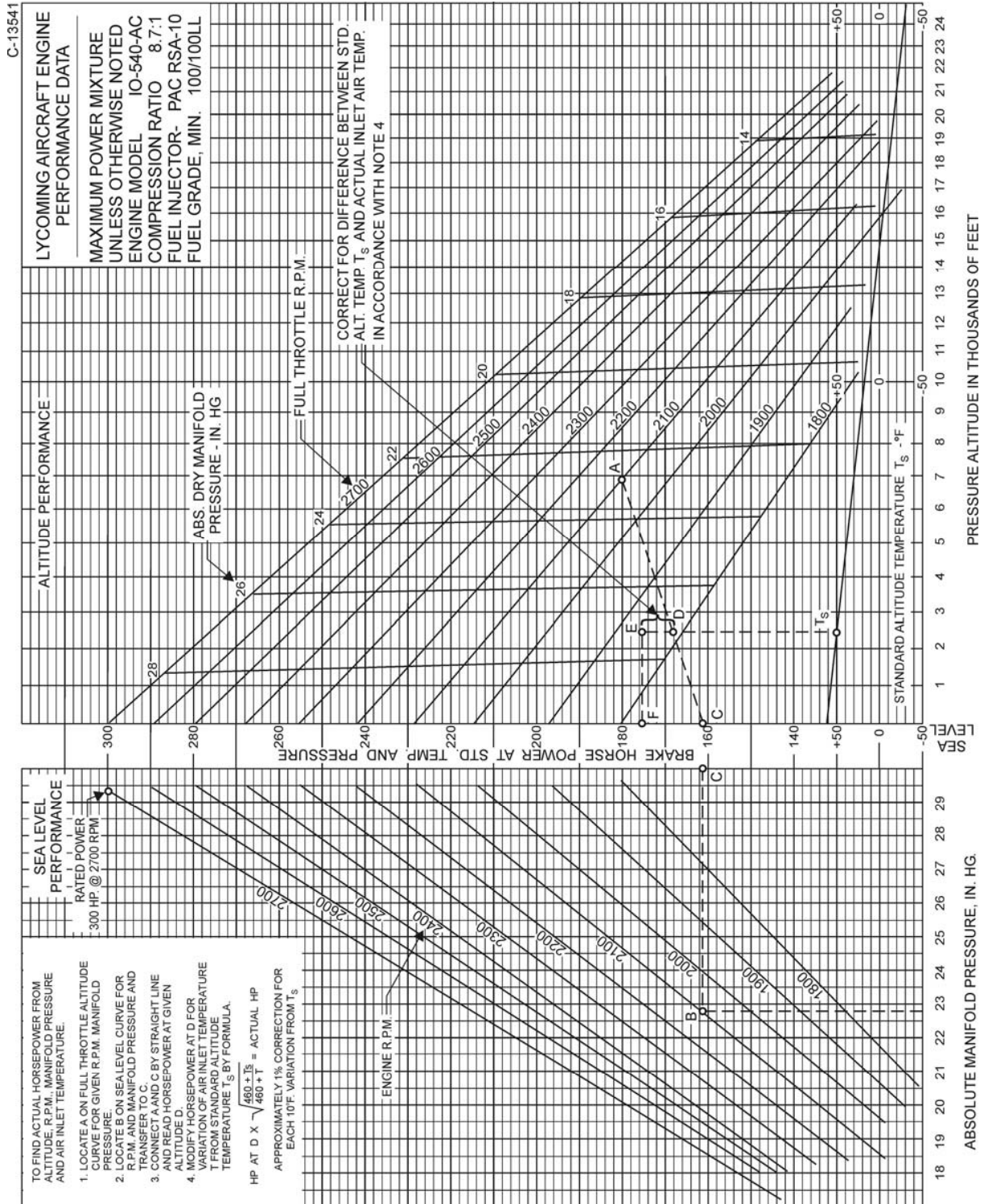

Figure 3-30. Sea Level and Altitude Performance Curve – IO-540-AC Series

FUEL FLOW vs PERCENT RATED POWER

LYCOMING IO-540-AE1A5

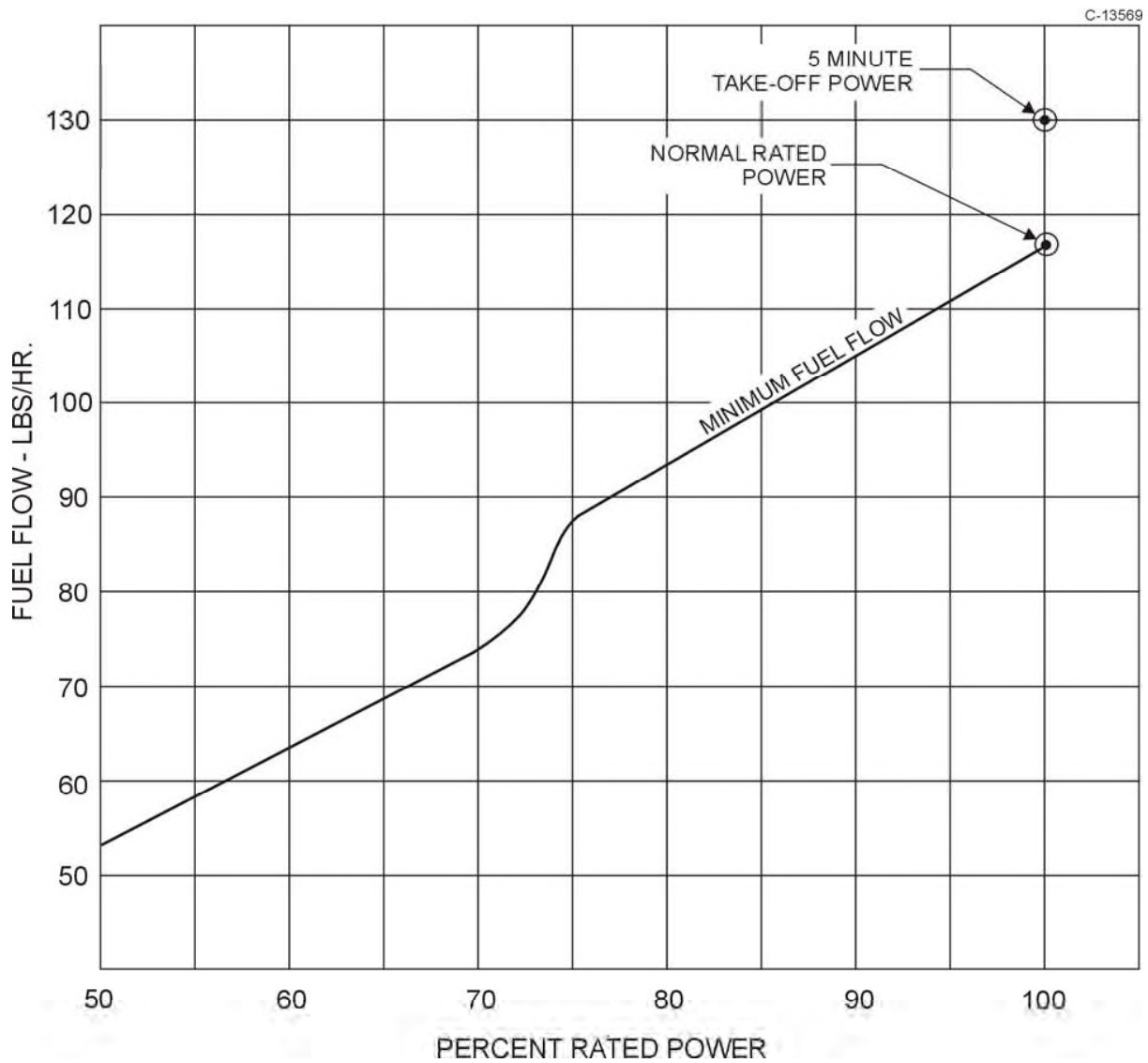
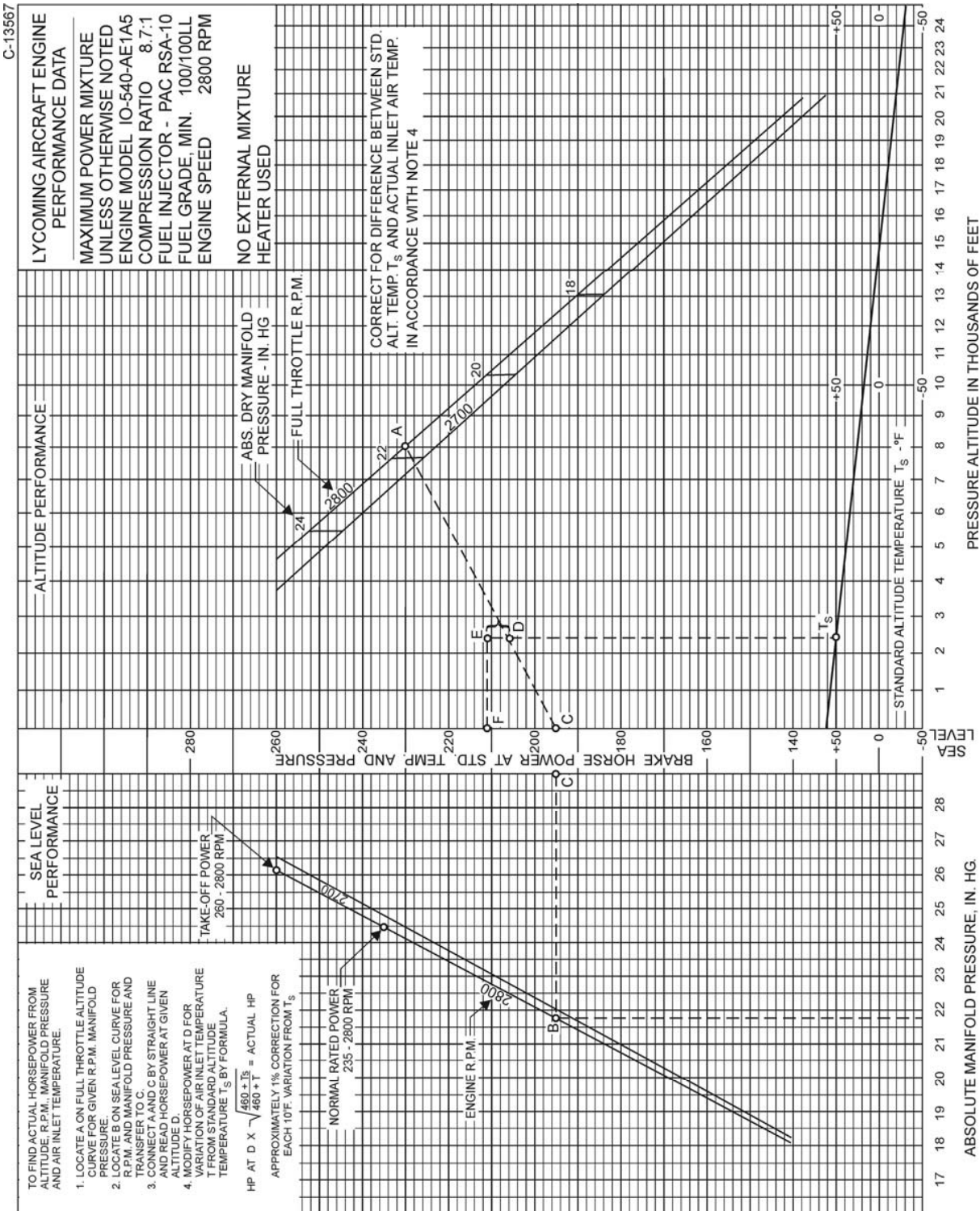

Figure 3-30. Fuel Flow vs Percent Rated Power –
IO-540-AE Series



Sea Level and Altitude Performance Curve – IO-540-AE Series

LYCOMING OPERATOR'S MANUAL

SECTION 4 PERIODIC INSPECTIONS

	Page
General.....	4-1
Pre-Starting Inspection	4-1
Daily Pre-Flight Inspection	4-2
10-Hour Inspection	4-2
25-Hour Inspection	4-2
50-Hour Inspection	4-2
100-Hour Inspection	4-3
400-Hour Inspection	4-4
Non-Scheduled Inspections	4-4

This Page Intentionally Left Blank

**SECTION 4
PERIODIC INSPECTIONS**

NOTE

Perhaps no other factor is quite so important to safety and durability of the aircraft and its components as faithful and diligent attention to regular checks for minor troubles and prompt repair when they are found.

The operator should bear in mind that the items listed in the following pages do not constitute a complete aircraft inspection, but are meant for the engine only. Consult the airframe manufacturer's handbook for additional instructions.

Pre-Starting Inspection – The daily pre-flight inspection is a check of the aircraft prior to the first flight of the day. This inspection is to determine the general condition of the aircraft and engine.

The importance of proper pre-flight inspection cannot be over emphasized. Statistics prove several hundred accidents occur yearly directly responsible to poor pre-flight.

Among the major causes of poor pre-flight inspection are lack of concentration, reluctance to acknowledge the need for a check list, carelessness bred by familiarity and haste.

**SECTION 4
PERIODIC INSPECTIONS**

**LYCOMING OPERATOR'S MANUAL
O-540, IO-540 SERIES**

1. DAILY PRE-FLIGHT (ENGINE).

- a. Be sure all switches are in the "Off" position.
- b. Be sure magneto ground wires are connected.
- c. Check oil level.
- d. Check fuel level.
- e. Check fuel and oil line connections, note minor indications for repair at 50-hour inspection. Repair any leaks before aircraft is flown.
- f. Open the fuel drain to remove any accumulation of water and sediment.
- g. Make sure all shields and cowling are in place and secure. If any are missing or damaged, repair or replacement should be made before the aircraft is flown.
- h. Check controls for general condition, travel and freedom of operation.
- i. Induction system air filter should be inspected and serviced in accordance with the airframe manufacturer's recommendations.

2. 10-HOUR INSPECTION (ENGINE). After the first ten (10) hours of operating time, new, rebuilt, or newly overhauled engines replace the oil filter, and conduct an inspection of the contents of the used oil filter for traces of metal particles.

3. 25-HOUR INSPECTION (ENGINE). At twenty-five (25) hours of operating time since the first inspection, new, rebuilt, or newly overhauled engines should undergo a 50-hour inspection including draining and renewing lubricating oil, replacing the oil filter, and inspecting the contents of the used oil filter.

NOTE

If the engine does not have a full-flow oil filter, change oil every 25 hours; also, inspect oil pressure and suction screens for metal contamination, and clean thoroughly before reinstallation.

4. 50-HOUR INSPECTION (ENGINE). In addition to the items listed for daily pre-flight inspection, the following maintenance checks should be made after every 50 hours of operation.

a. Ignition System –

- (1) If fouling of spark plugs has been apparent, clean them and check electrode gap. Rotate bottom plugs to upper position.
- (2) Examine spark plug leads of cable and ceramics for corrosion and deposits. This condition is evidence of either leaking spark plugs, improper cleaning of the spark plug walls or connector ends. Where this condition is found, clean the cable ends, spark plug walls and ceramics with a dry, clean cloth or a clean cloth moistened with methyl-ethyl-ketone. All parts should be clean and dry before reassembly.
- (3) Check ignition harness for security of mounting clamps and be sure connections are tight at spark plug and magneto terminals.

- b. Fuel Line and Induction System* – Check the primer lines for leaks and security of the clamps. Remove and clean the fuel inlet strainers. Check the mixture control and throttle linkage for travel, freedom of movement, security of the clamps and lubricate if necessary. Check the air intake ducts for leaks, security, filter damage; evidence of dust or other solid material in the ducts is indicative of inadequate filter care or damaged filter. Check vent lines for evidence of fuel or oil seepage; if present, fuel pump may require replacement.
- c. Lubrication System* –
- (1) Check oil lines for leaks, particularly at connections; for security of anchorage and for wear due to rubbing or vibration, for dents and cracks.
 - (2) Replace elements on external full-flow oil filters. Before disposing of used element check interior folds for traces of metal particles that might be evidence of internal engine damage. Drain and renew lubricating oil. (Reference latest revision of Service Instruction No. 1014 for proper oil.)
- d. Exhaust System* – Check attaching flanges at exhaust ports on cylinders for evidence of leakage. If they are loose, they must be removed and machined flat before they are reassembled and tightened. Examine exhaust manifolds for general condition.
- e. Cooling System* – Check cowling, baffles and baffle seals for damage and secure anchorage. Any damaged or missing part of the cooling system must be repaired or replaced before the aircraft resumes operation.
- f. Cylinders* – Check rocker box covers for evidence of oil leaks. If found, replace gasket and tighten screws to specified torque (50 in.-lbs.).

Check cylinders for evidence of excessive heat which is indicated by burned paint on the cylinder. This condition is indicative of internal damage to the cylinder and, if found, its cause must be determined and corrected before the aircraft resumes operation.

Heavy discoloration and appearance of seepage at cylinder head and barrel attachment area is usually due to emission of thread lubricant used during assembly of the barrel at the factory, or by slight gas leakage which stops after the cylinder has been in service for awhile. This condition is neither harmful nor detrimental to engine performance and operation. If it can be proven that leakage exceeds these conditions, the cylinder should be replaced.

5. 100-HOUR INSPECTION. In addition to the items listed for daily pre-flight, and 50-hour inspection, the following maintenance checks should be made after every one hundred hours of operation.

- a. Electrical System* –
- (1) Check all wiring connected to the engine or accessories. Any shielded cables that are damaged should be replaced. Replace clamps or loose wires and check terminals for security and cleanliness.
 - (2) Remove spark plugs; test, clean, regap, and rotate them. Replace if necessary.

SECTION 4
PERIODIC INSPECTIONS

LYCOMING OPERATOR'S MANUAL
O-540, IO-540 SERIES

- b. *Lubrication System* – Drain and renew lubricating oil.
 - c. *Magnetos* – Check breaker points for pitting and minimum gap. Check for excessive oil in the breaker compartment, if found, wipe dry with a clean lintless cloth. The felt located at the breaker points should be lubricated in accordance with the magneto manufacturer's instructions. Check magneto to engine timing. (Timing procedures for Bendix and Slick magnetos are covered in the Maintenance Procedures Section.)
 - d. *Engine Accessories* – Engine mounted accessories such as pumps, temperature and pressure sensing units should be checked for secure mounting, tight connections.
 - e. *Cylinders* – Check cylinders visually for cracked or broken fins.
 - f. *Engine Mounts* – Check engine mounting bolts and bushings for security and excessive wear. Replace any excessive wear. Replace any bushings that are excessively worn.
 - g. *Primer Nozzles* – Disconnect primer nozzles from engine and check for equal flow.
 - h. *Fuel Injector Nozzles and Lines* – Check fuel injector nozzles for looseness. Tighten to 60 in.-lbs. torque. Check fuel line for dye stains at connections (indicating leakage) and security of lines. Repair or replacement must be accomplished before aircraft resumes operation.
 - i. *Carburetor* – Check throttle body attaching screws for tightness; the correct torque for these screws is 40-50 in.-lbs.
6. **400-HOUR INSPECTION.** In addition to the items listed for daily pre-flight, 50-hour and 100-hour inspections, the following maintenance check should be made after every 400 hours of operation.

Valve Inspection – Remove rocker box covers and check for freedom of valve rockers when valves are closed. Look for evidence of abnormal wear or broken parts in the area of the valve tips, valve keeper, springs and spring seats. If any indications are found, the cylinder and all of its components should be removed (including the piston and connecting rod assembly) and inspected for further damage. Replace any parts that do not conform with limits shown in the latest revision of Special Service Publication No. SSP-1776.

7. **NON-SCHEDULED INSPECTIONS.** Occasionally, service bulletins or service instructions are issued by Lycoming that require inspection procedures that are not listed in this manual. Such publications, usually are limited to specified engine models and become obsolete after corrective modification has been accomplished. All such publications are available from Lycoming distributors, or from the factory by subscription. Consult the latest revision of Service Letter No. L114 for subscription information. Maintenance facilities should have an up-to-date file of these publications available at all times.

LYCOMING OPERATOR'S MANUAL

SECTION 5 MAINTENANCE PROCEDURES

	Page
General.....	5-1
Ignition and Electrical System	
Ignition Harness and Wire Replacement.....	5-1
Timing Magneto to Engine.....	5-1
Generator or Alternator Output	5-7
Fuel System	
Repair of Fuel Leaks.....	5-7
Carburetor or Fuel Injector Inlet Screen Assembly.....	5-7
Fuel Grades and Limitations	5-7
Air Intake Ducts and Filter	5-7
Idle Speed and Mixture Adjustment.....	5-7
Lubrication System	
Oil Grades and Limitations.....	5-8
Oil Suction and Oil Pressure Screens	5-8
Oil Relief Valve	5-8
Cylinders.....	5-9
Generator or Alternator Drive Belt Tension.....	5-12

This Page Intentionally Left Blank

SECTION 5

MAINTENANCE PROCEDURES

The procedures described in this section are provided to guide and instruct personnel in performing such maintenance operations that may be required in conjunction with the periodic inspections listed in the preceding section. No attempt is made to include repair and replacement operations that will be found in the applicable Lycoming Overhaul Manual.

1. IGNITION AND ELECTRICAL SYSTEM.

- a. *Ignition Harness and Wire Replacement* – In the event that an ignition harness or an individual lead is to be replaced, consult the wiring diagram to be sure harness is correctly installed. Mark location of clamps and clips to be certain the replacement is clamped at correct locations.
- b. *Timing Magnetos to Engine (Bendix)* –
 - (1) Remove a spark plug from No. 1 cylinder and place a thumb over the spark plug hole. Rotate the crankshaft in direction of normal rotation until the compression stroke is reached, which is indicated by a positive pressure inside the cylinder tending to push the thumb off the spark plug hole. Continue rotating the crankshaft until the advance timing mark on the front face of the starter ring gear is in alignment with the small hole located at the two o'clock position on the front face of the starter housing. (Refer to Specification chapter or to engine nameplate for designated number of degrees of spark advance.) At this point, the engine is ready for assembly of the magnetos.
 - (2) *Single Magneto* – Remove the inspection plugs from both magnetos and turn the drive shaft in direction of normal rotation until (-20 and -200 series) the first painted chamfered tooth on the distributor gear is aligned in the center of the inspection window (-1200 series) the applicable timing mark on the distributor gear is approximately aligned with the mark on the distributor block. See Figure 5-2. Being sure the gear does not move from this position, install gaskets and magnetos on the engine. Note that an adapter is used with all magnetos. Secure with (clamps on -1200 series) washers and nuts; tighten only finger tight.
 - (3) Using a battery-powered timing light, attach the positive lead to a suitable terminal connected to the switch terminal of the magneto and the negative lead to any unpainted portion of the engine. Rotate the magneto in its mounting flange to a point where the light comes on, then slowly turn it in the opposite direction until the light goes out. Bring the magneto back slowly until the light just comes on. Repeat this with the second magneto.
 - (4) Back off the crankshaft a few degrees; the timing light should go out. Bring the crankshaft slowly back in direction of normal rotation until the timing mark and the hole in the starter housing are in alignment. At this point, both lights should go on simultaneously. Tighten nuts to specified torque.
 - (5) *Dual Magnetos* – Place the engine in the No. 1 advance firing position as directed in paragraph 1b(1).
 - (6) Install the magneto-to-engine gasket on the mounting flange.

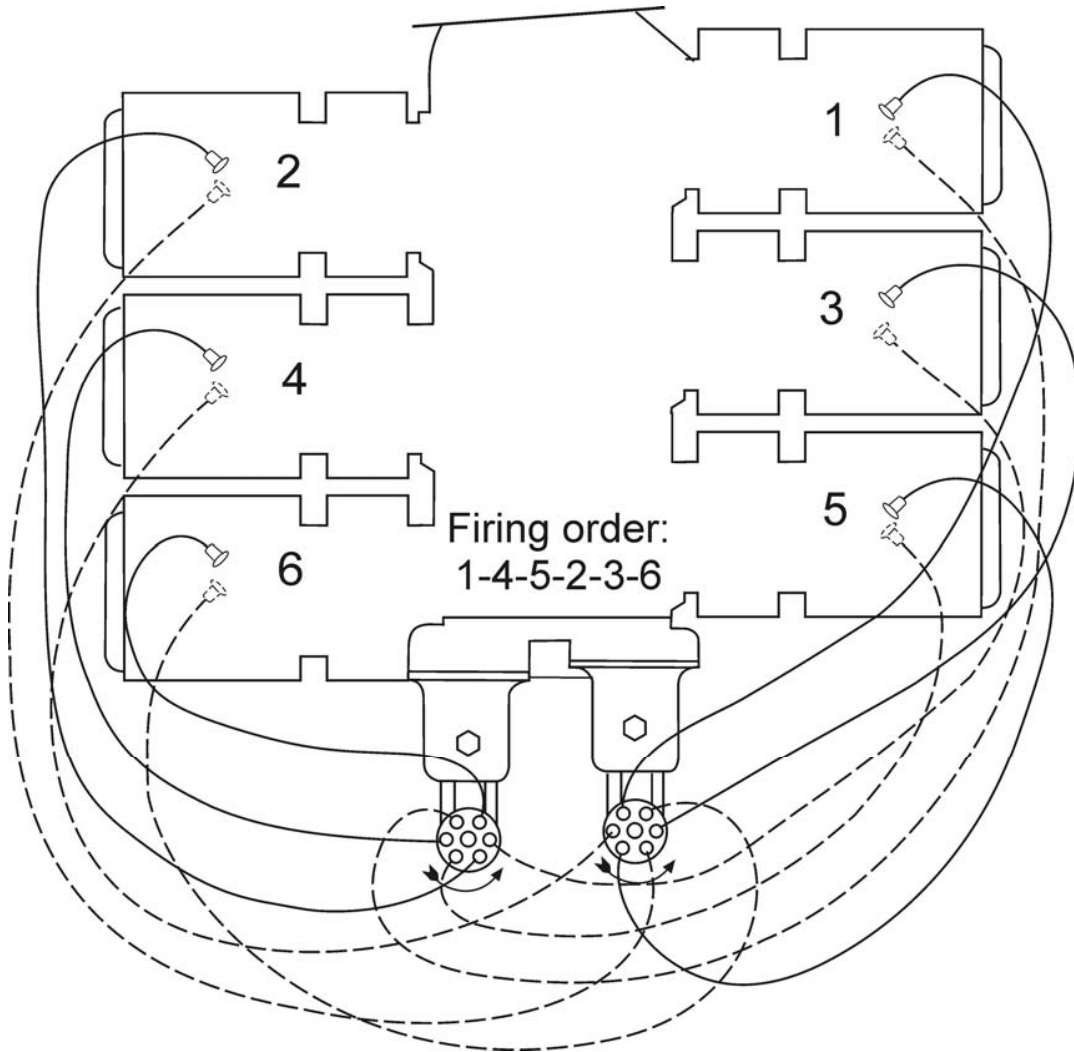

Figure 5-1. Ignition Wiring Diagram

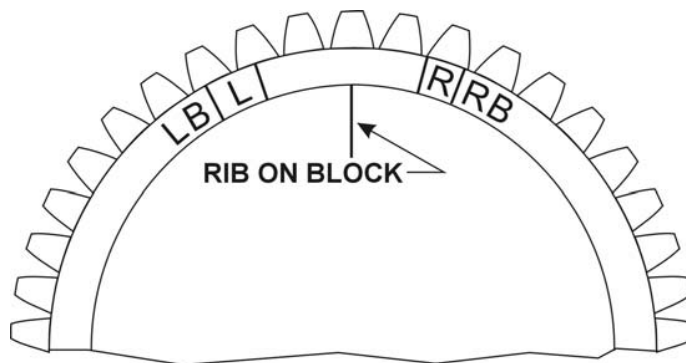

Figure 5-2. Timing Marks – 6 Cylinder –1200 Series

WARNING

DO NOT ATTACH HARNESS SPARK PLUG ENDS TO THE SPARK PLUGS UNTIL ALL MAGNETO-TO-ENGINE TIMING PROCEDURES AND MAGNETO-TO-SWITCH CONNECTIONS ARE ENTIRELY COMPLETED.

- (7) To remove engine-to-magneto drive gear train backlash, turn engine magneto drive as far as possible in direction opposite to normal rotation; then return in the direction of normal rotation to timing mark on starter support.
- (8) Remove the timing window plug from the most convenient side of the magneto housing and the plug from the rotor viewing location in the center of the housing.
- (9) Turn the rotating magnet drive shaft in the normal direction of magneto rotation until the painted tooth of the large distributor gear is centered in the timing hole.
- (10) Observe that at this time the built in pointer just ahead of the rotor viewing window aligns with the R or L mark on the rotor depending on whether the magneto is of right or left hand rotation as specified on the magneto nameplate.
- (11) Hold the magneto in its No. 1 firing position (tooth in window center and pointer over R or L mark on rotor) and install magneto to the engine and loosely clamp in position.
- (12) Attach red lead from the timing light to left switch adapter lead, green lead of timing light to right switch adapter lead and the black lead of the light to magneto housing.
- (13) Turn the entire magneto in direction of rotor rotation until the red timing light comes on.
- (14) Rotate the magneto in the opposite direction until the red light just goes off indicating left main breaker has opened. Then evenly tighten the magneto mounting clamps.
- (15) Back the engine up approximately 10° and then carefully “bump” the engine forward at the same time observing the timing lights.
- (16) At the No. 1 firing position of the engine, the red light should go off indicating left main bearing opening. The right main breaker, monitored by the green light, must open within ± 2 engine degrees of the No. 1 firing position.
- (17) Repeat steps (13) thru (15) until the condition described in paragraph (16) is obtained.
- (18) Complete tightening of the magneto securing clamps by torquing to 150 in.-lbs.
- (19) Recheck timing once more and if satisfactory disconnect timing light. Remove adapter leads.
- (20) Reinstall plugs in timing inspection holes and torque to 12-15 in.-lbs.

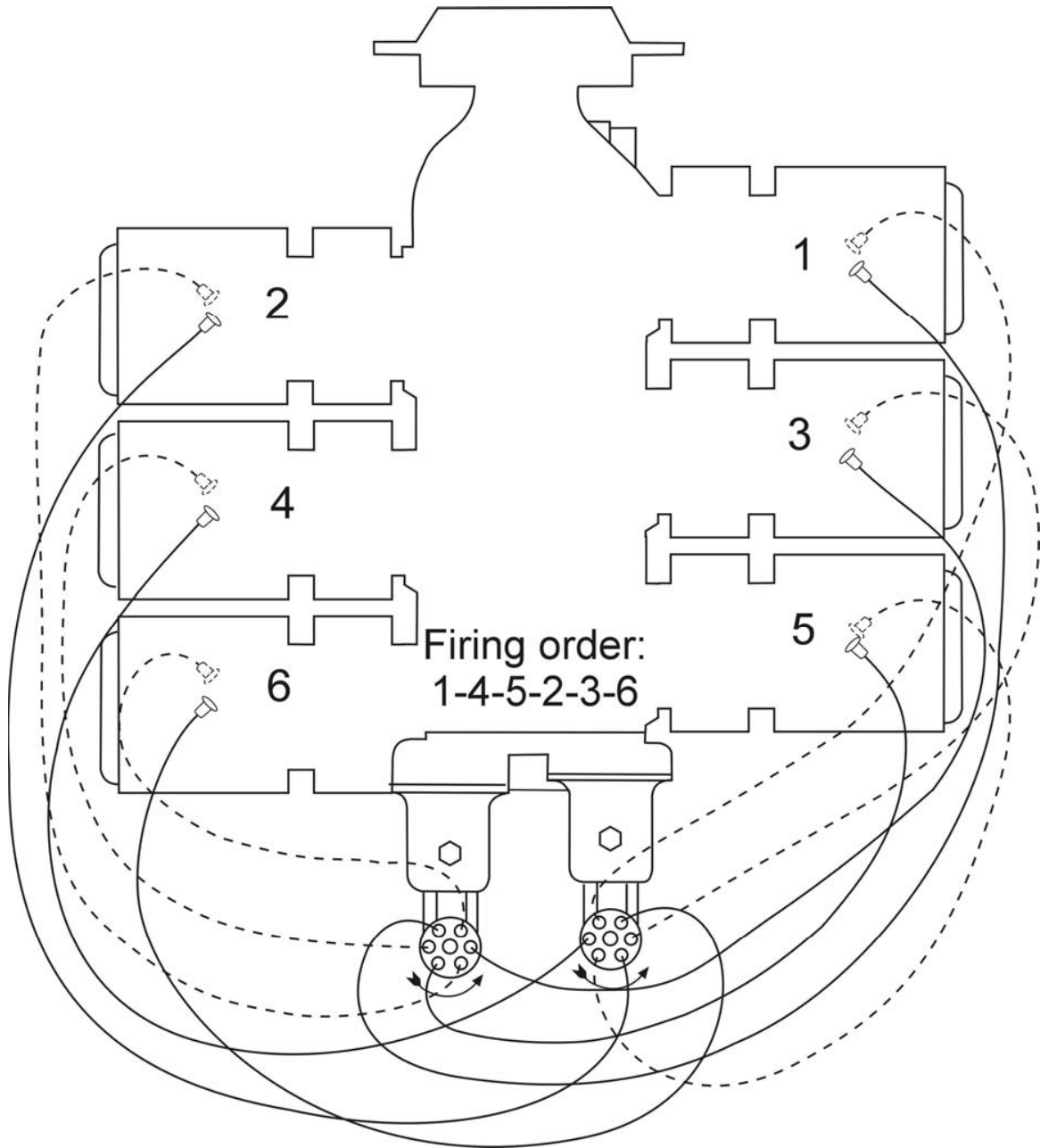

Figure 5-3. Ignition Wiring Diagram – Dual Magneto

c. Timing Magnetos to Engine (Slick) –

- (1) Remove a spark plug from No. 1 cylinder and place a thumb over the spark plug hole. Rotate the crankshaft in direction of normal rotation until the compression stroke is reached; this is indicated by a positive pressure inside the cylinder tending to push the thumb off the spark plug hole. Continue rotating the crankshaft until the advance timing mark on the front face of the starter ring gear is in alignment with the small hole located at the two o'clock position on the front face of the starter housing. (Refer to Specification chapter or to engine nameplate for designated number of degrees of spark advance.) At this point, the engine is ready for assembly of the magnetos.
- (2) Remove the ignition harness from the left (retard breaker) magneto, if installed. Insert the Slick T-118 timing pin in the hole marked "L" on the face of the distributor block. Apply a slight inward pressure to the pin and slowly rotate the magneto drive shaft clockwise until the shoulder of the pin seats against the distributor block. When properly engaged, the timing pin will be inserted 7/8 inch into the distributor block.

NOTE

If the magneto shaft cannot be rotated and if the timing pin is not seated 7/8 inch into the distributor block, remove the pin, rotate the drive shaft 1/8 turn and repeat the insertion procedure.

CAUTION

DO NOT ROTATE THE MAGNETO ROTOR SHAFT WITH THE TIMING PIN INSERTED INTO THE DISTRIBUTOR BLOCK. THIS COULD DAMAGE THE INTERNAL COMPONENTS OF THE MAGNETO.

- (3) Inspect the left magneto accessory housing mounting pad to ensure that magneto drive dampers, adapter, and gaskets are there and installed properly. Position the magneto on its side with the top of the magneto located outboard away from the accessory housing vertical centerline. Install the magneto onto the mounting pad. Be sure the drive dampers remain in place when the magneto drive is inserted into the drive gear. Secure the magneto to the accessory housing with the proper clamps, washers, and nuts. Tighten nuts only finger tight.

CAUTION

DO NOT ROTATE THE MAGNETO OR ENGINE WITH THE TIMING PIN INSERTED INTO THE MAGNETO DISTRIBUTOR BLOCK. THIS COULD CAUSE DAMAGE TO THE INTERNAL COMPONENTS OF THE MAGNETO.

- (4) Remove the timing pin from the distributor block.
- (5) Repeat steps (2), (3), (4) for the right (plain) magneto.

WARNING

DO NOT ATTACH HARNESS SPARK PLUG ENDS TO THE SPARK PLUGS UNTIL ALL MAGNETO-TO-ENGINE TIMING PROCEDURES AND MAGNETO-TO-SWITCH CONNECTIONS ARE ENTIRELY COMPLETED.

SECTION 5
MAINTENANCE PROCEDURES

LYCOMING OPERATOR'S MANUAL
O-540, IO-540 SERIES

- (6) Attach a timing light to the magneto condenser stud according to the timing light manufacturer's instructions.
- (7) Rotate the magneto assembly in the direction of rotor rotation until the timing light comes on. If the light is on initially, rotation of the magneto is not required. This indicates the breaker points are closed.
- (8) Slowly rotate the magneto assembly in the opposite direction, until the light goes out or the breaker points open.
- (9) Alternately tighten the magneto mounting nut clamps to 8 ft.-lbs. torque. Continue to tighten both nuts alternately, in several steps, to 17 ft.-lbs. torque.
- (10) Repeat steps (6) thru (9) for the second magneto.
- (11) Rotate the engine approximately 10° opposite to the normal rotational direction. The timing lights should light. Slowly (bump) rotate the engine in the normal direction until the timing lights go out. Both lights should go out within $\pm 1^\circ$ of the designated timing mark on ring gear with the dot on the starter housing as referenced in step (1).
- (12) Repeat steps (6) thru (10) until the condition described in step (11) is satisfied.
- (13) If the magneto position ($\pm 15^\circ$ from the mounting pad horizontal centerline allowed) interference is encountered, which is unlikely, the magneto must be removed and the drive gear in the accessory housing repositioned. Care must be taken not to drop the dampers into the engine during the repositioning of the drive gear.
- (14) Remove timing light leads from the magnetos.
- (15) Attach the appropriate switch or P-Leads to the condenser terminal of each magneto using a lockwasher and nut. Torque nut to 13-15 in.-lbs.
- (16) *Retard Breaker* – Attach one positive lead of the timing light to retard breaker terminal and the negative lead to ground. Set the engine required number of degrees before top center on the compression stroke of the number 1 cylinder. The timing light should be on, indicating the retard breaker points are closed. Slowly rotate the engine in the normal direction until the timing light goes out indicating the points opened. The TC #1 timing mark on the ring gear should be aligned with the dot on the starter housing within $\pm 3^\circ$. If the timing of these points is incorrect, refer to the Slick Maintenance Manual for the procedure and proper adjustment of the contact points.
- (17) Attach the switch retard breaker lead to the retard post on the magneto (left magneto only) using a lockwasher and nut. Torque nut to 13-15 in.-lbs.
- (18) Install ignition harness assemblies on the magnetos. The left magneto harness is marked "left" and the right magneto harness is marked "right". Check for proper installation of the "O" ring seal in the wire cap. Torque cap-mounting screws to 18-20 in.-lbs.

NOTE

Some timing lights operate in the reverse manner as described. The light comes on when the breaker points open. Check your timing light instructions.

- c. *Generator or Alternator Output* – Check the generator or alternator (whichever is applicable) to determine that the specified voltage and current are being obtained.

2. FUEL SYSTEM.

- a. *Repair of Fuel Leaks* – In the event a line or fitting in the fuel system is replaced, use only a fuel-soluble lubricant, such as Loctite Hydraulic Sealant. Do not use Teflon tape or any other form of thread compound. Do not apply sealant to the first two threads.
- b. *Carburetor or Fuel Injector Inlet Screen Assembly* – Remove the assembly and check the screen for distortion or openings in the strainer. Replace for either of these conditions. Clean screen assembly in solvent and dry with compressed air. To install the screen assembly, place the gasket on the screen assembly and install the assembly in the throttle body and tighten to 35-40 inch pounds torque for carburetor or 60-70 inch pounds torque for fuel injector.
- c. *Fuel Grades and Limitations* – See recommended fuel grades in Section 3, or reference latest revision of Service Instruction No. 1070.

In the event that the specified fuel is not available at some locations, it is permissible to use higher octane fuel. Fuel of a lower octane than specified is not to be used. Do not use automotive fuel regardless of octane rating.

NOTE

Refer to the latest revision of Service Instruction No. 1070 regarding specified fuel for Lycoming engines.

- d. *Air Intake Ducts and Filter* – Check all air intake ducts for dirt or restrictions. Inspect and service air filters as instructed in the airframe manufacturer's handbook.
- e. *Idle Speed and Mixture Adjustment* –
 - (1) Start the engine and warm up in the usual manner until oil and cylinder head temperatures are normal.
 - (2) Check magnetos. If the "mag-drop" is normal (refer to Section 3.6), proceed with idle adjustment.
 - (3) Set throttle stop screw so that the engine idles at the aircraft manufacturer's recommended idling RPM. If the RPM changes appreciably after making idle mixture adjustment during the succeeding steps, readjust the idle speed to the desired RPM.

- (4) When the idling speed has been stabilized, move the cockpit mixture control lever with a very slow, steady pull toward the "Idle Cut-Off" position and observe the tachometer for any change during the leaning process. Caution must be exercised to return the mixture control to the "Full Rich" position before the RPM can drop to a point where the engine cuts out. An increase of more than 35 RPM while "leaning out" indicates an excessively rich idle mixture. An immediate decrease in RPM (if not preceded by a momentary increase) indicates the idle mixture is too lean.

If the above indicates that the idle adjustment is too rich or too lean, turn the idle mixture adjustment in the direction required for correction, and check this new position by repeating the above procedure. Make additional adjustments as necessary until a check results in a momentary pickup of approximately 10 to 25 RPM. Each time the adjustment is changed, the engine should be run up to 2000 RPM to clear the engine before proceeding with the RPM check. Make final adjustment of the idle speed adjustment to obtain the desired idling RPM with closed throttle. The above method aims at a setting that will obtain maximum RPM with minimum manifold pressure. In case the setting does not remain stable, check the idle linkage; any looseness in this linkage would cause erratic idling. In all cases, allowance should be made for the effect of weather conditions and field altitude upon idling adjustment.

3. LUBRICATION SYSTEM.

- a. *Oil Grades and Limitations* – Service the engine in accordance with the recommendations shown in Section 3.
- b. *Oil Suction and Oil Pressure Screens* – At each fifty hours inspection remove, inspect for metal particles, clean and reinstall.

NOTE

If an engine does not have a full-flow oil filter, change oil every 25 hours; also, inspect oil pressure and suction screens for metal contamination, and clean thoroughly before reinstallation.

- c. *Oil Relief Valve (Non-Adjustable)* – The function of the oil pressure relief valve is to maintain engine oil pressure within specified limits. The valve, although not adjustable, may be controlled by the addition of a maximum of nine STD-425 washers under the cap to increase pressure or the use of a spacer (Lycoming P/N 73629 or 73630) to decrease pressure. A modification on later models has eliminated the need for the spacers. Particles of metal or other foreign matter lodged between the ball and seat will result in faulty readings. It is advisable, therefore, to disassemble, inspect and clean the valve if excessive pressure fluctuations are noted.
- d. *Oil Relief Valve (Adjustable)* – The adjustable oil relief valve enables the operator to maintain engine oil pressure within the specified limits. If the pressure under normal operating conditions should consistently exceed the maximum or minimum specified limits, adjust the valve as follows.

With the engine warmed up and running at approximately 2000 RPM, observe the reading on the oil pressure gage. If the pressure is above maximum or below minimum specified limits, stop engine and screw the adjusting screw out to decrease pressure and in to increase pressure. Depending on installation, the adjusting screw may have only a screw driver slot; or it may have the screw driver slot plus a pinned .375-24 castellated nut and may be turned with either a screw driver or a box wrench.

NOTE

Check applicable parts catalog for optional size/pressure capacity relief- valve springs.

4. **CYLINDERS.** It is recommended that as a field operation, cylinder maintenance be confined to replacement of the entire assembly. For valve replacement consult the proper overhaul manual. This should be undertaken only as an emergency measure.

a. Removal of Cylinder Assembly –

- (1) Remove exhaust manifold and cooling baffles.
- (2) Remove rocker box drain tube, intake pipe, baffle and any clips that might interfere with the removal of the cylinder.
- (3) Disconnect ignition cables and remove the bottom spark plug.
- (4) Remove rocker box cover and rotate crankshaft until piston is approximately at top center of the compression stroke. This is indicated by a positive pressure inside of cylinder tending to push thumb off of bottom spark plug hole.
- (5) Slide valve rocker shafts from cylinder head and remove the valve rockers. Valve rocker shafts can be removed after the cylinder is removed from the engine. Remove rotator cap from exhaust valve stem.
- (6) Remove push rods by grasping ball end and pulling rod out of shroud tube. Detach shroud tube spring and lock plate and pull shroud tubes through holes in cylinder head.

NOTE

The hydraulic tappets, push rods, rocker arms and valves must be assembled in the same location from which they were removed.

- (7) Remove cylinder base nuts and hold down plugs (where employed), then remove cylinder by pulling directly away from crankcase. Be careful not to allow the piston to drop against the crankcase as the piston leaves the cylinder.
- b. Removal of Piston from Connecting Rod –* Remove the piston pin plugs. Insert piston pin puller (P/N 64843) through piston pin, assemble puller nut; then proceed to remove piston pin. Do not allow connecting rod to rest on the cylinder bore of the crankcase. Support the connecting rod with heavy rubber band, discarded cylinder base oil ring seal, or any other non-marring method.
- c. Removal of Hydraulic Tappet Sockets and Plunger Assemblies –* It will be necessary to remove and bleed the hydraulic tappet plunger assembly so that dry tappet clearance can be checked when the cylinder assembly is reinstalled. This is accomplished in the following manner:
- (1) Remove the hydraulic tappet push rod socket by inserting the forefinger into the concave end of the socket and withdrawing. If the socket cannot be removed in this manner, it may be removed by grasping the edge of the socket with a pair of needle nose pliers. However, care must be exercised to avoid scratching the socket.

- (2) To remove the hydraulic tappet plunger assembly, use the special Lycoming service tool. In the event that the tool is not available, the hydraulic tappet plunger assembly may be removed by a hook in the end of a short piece of lockwire, inserting the wire so that the hook engages the spring of the plunger assembly. Draw the plunger assembly out of the tappet body by gently pulling the wire.

CAUTION

NEVER USE A MAGNET TO REMOVE HYDRAULIC PLUNGER ASSEMBLIES FROM THE CRANKCASE. THIS CAN CAUSE THE CHECK BALL TO REMAIN OFF ITS SEAT, RENDERING THE UNIT INOPERATIVE.

- d. *Assembly of Hydraulic Tappet Plunger Assemblies* – To assemble the unit, unseat the ball by inserting a thin clean wire through the oil inlet hole. With the ball off its seat, insert the plunger and twist clockwise so that the spring catches. All oil must be removed before the plunger is inserted.
- e. *Assembly of Cylinder and Related Parts* – Rotate the crankshaft so that the connecting rod of the cylinder being assembled is at the top center of compression stroke. This can be checked by placing two fingers on the intake and exhaust tappet bodies. Rock crankshaft back and forth over top center. If the tappet bodies do not move, the crankshaft is on the compression stroke.

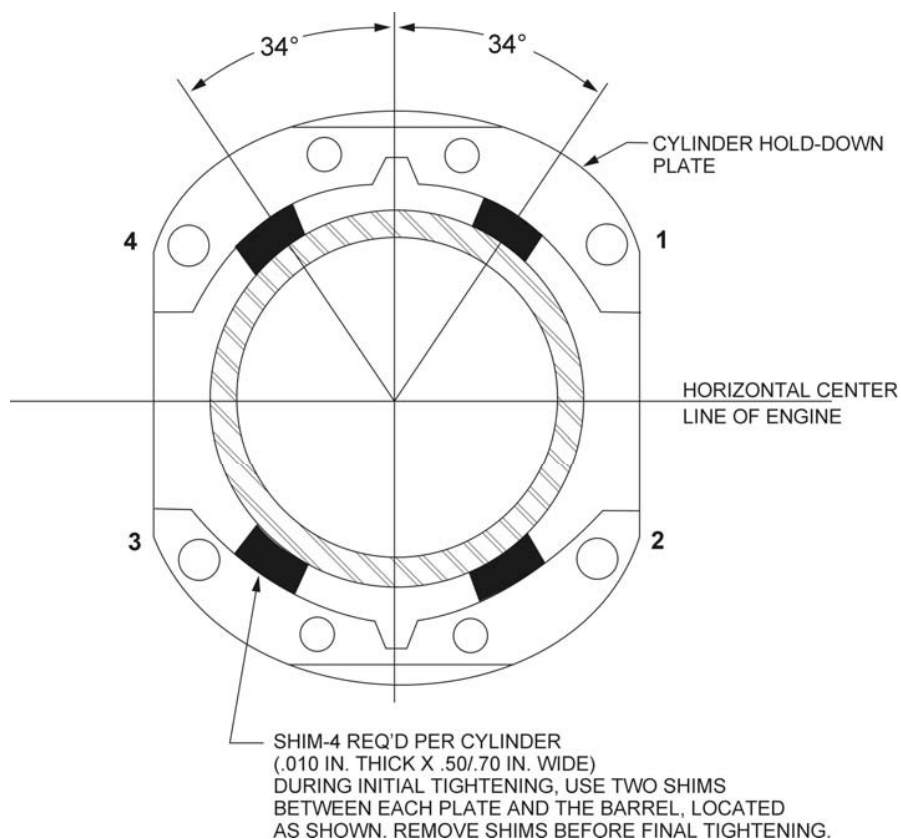

Figure 5-4. Location of Shims Between Cylinder Barrel and Hold-Down Plates (where applicable) and Sequence of Tightening Cylinder Base Hold-Down Nuts

- (1) Place each plunger assembly in its respective tappet body and assemble the socket on top of plunger assembly.
- (2) Assemble piston with rings so that the number stamped on the piston pin boss is toward the front of the engine. The piston pin should be of a hand push fit. If difficulty is experienced in inserting the piston pin, it is probably caused by carbon or burrs in the piston pin hole. During assembly, always use a generous quantity of oil, both in the piston pin hole and on the piston pin.
- (3) Assemble one piston pin plug at each end of the piston pin and place a new rubber oil seal ring around the cylinder skirt. Coat piston and rings and the inside of the cylinder generously with oil.
- (4) Space piston ring gaps. Then, using a piston ring compressor, assemble the cylinder over the piston so that the intake port is at the bottom of the engine. Push the cylinder all the way on, catching the ring compressor as it is pushed off.

NOTE

Before installing cylinder hold-down nuts, lubricate crankcase thru-stud threads with any one of the following lubricants, or combinations of lubricants.

1. 90% SAE 50W engine oil and 10% STP.
 2. Parker Thread Lube.
 3. 60% SAE 30 engine oil and 40% Parker Thread Lube.
- (5) Assemble hold-down plates (where applicable) and cylinder base hold-down nuts and tighten as directed in the following steps.

NOTE

At any time a cylinder is replaced, it is necessary to retorque the thru-studs on the cylinder on the opposite side of the engine.

- (a) (*Engines using hold-down plates*) – Install shims between cylinder base hold-down plates and cylinder barrel, as directed in Figure 5-4, and tighten ½ inch hold-down nuts to 300 in.-lbs. (25 ft.-lbs.) torque, using the sequence shown in Figure 5-4.
- (b) Remove shims, and using the same sequence, tighten the ½ inch cylinder base nuts to 600 in.-lbs. (50 ft.-lbs.) torque.

NOTE

Cylinder assemblies not using hold-down plate are tightened in the same manner as above omitting the shims.

- (c) Tighten the 3/8 inch hold-down nuts to 300 in.-lbs. (25 ft.-lbs.) torque. Sequence of tightening is optional.
- (d) After completing tightening sequence, recheck final torque value.

CAUTION

AFTER ALL CYLINDER BASE NUTS HAVE BEEN TIGHTENED, REMOVE ANY NICKS IN THE CYLINDER FINS BY FILING OR BURRING.

- (6) Install new shroud tube oil seals on both ends of shroud tube. Install shroud tube and lock in place as required for type of cylinder.
- (7) Assemble each push rod in its respective shroud tube. Then place rotator cap over end of exhaust valve stem. Assemble each rocker in its respective position by placing rocker between bosses and by sliding valve rocker shaft in place to retain rocker.
- (8) Be sure that the piston is at top center of compression stroke and that both valves are closed. Check clearance between the valve stem tip and the valve rocker. In order to check this clearance, place the thumb of one hand on the valve rocker directly over the end of the push rod and push down so as to compress the hydraulic tappet spring. While holding the spring compressed, the valve clearance should be between .028 and .080 inch. If clearance does not come within these limits, remove the push rod and insert a longer or shorter push rod, as required to correct clearance.

NOTE

Inserting a longer push rod will decrease the valve clearance.

- (9) Install intercylinder baffles, rocker box covers, intake pipes, rocker box drain tubes and exhaust manifold.

5. GENERATOR OR ALTERNATOR DRIVE BELT TENSION.

Check the tension of a new belt 25 hours after installation. Refer to latest revision of Service Instruction No. 1129 for methods of checking generator or alternator drive belt tension.

LYCOMING OPERATOR'S MANUAL

SECTION 6 TROUBLE-SHOOTING

	Page
Failure of Engine to Start.....	6-1
Failure of Engine to Idle Properly.....	6-2
Low Power and Uneven Running.....	6-2
Failure of Engine to Develop Full Power.....	6-3
Rough Engine.....	6-3
Low Oil Pressure.....	6-3
High Oil Temperature.....	6-4
Excessive Oil Consumption.....	6-4
High Fuel Flow Indication on Fuel Gage.....	6-4

This Page Intentionally Left Blank

**SECTION 6
TROUBLE-SHOOTING**

Experience has proven that the best method of trouble-shooting is to decide on the various causes of a given trouble and then to eliminate causes one by one, beginning with the most probable. The following charts list some of the more common troubles, which may be encountered in maintaining engines; their probable causes and remedies.

1. TROUBLE-SHOOTING – ENGINE.

TROUBLE	PROBABLE CAUSE	REMEDY
Failure of Engine to Start	Lack of fuel	Check if fuel valve is on. Check fuel system for leaks. Fill fuel tank. Clean dirty lines, strainers or fuel valves.
	Overpriming	Leave ignition "off" and mixture control in "Idle Cut-Off", open throttle and "unload" engine by cranking for a few seconds. Turn ignition switch on and proceed to start in a normal manner.
	Defective spark plugs	Clean and adjust or replace spark plugs.
	Defective ignition wire	Check with electric tester, and replace any defective wires.
	Defective battery	Replace with charged battery.
	Improper operation of magneto breaker	Check mag switch is on. Clean points. Check internal timing of magnetos.
	Lack of sufficient fuel flow	Disconnect fuel line and check fuel flow.
	Water in fuel injector or carb.	Drain fuel injector or carburetor and fuel lines.
	Internal failure	Check oil screens for metal particles. If found, complete overhaul of the engine may be indicated.

**SECTION 6
TROUBLE-SHOOTING**

**LYCOMING OPERATOR'S MANUAL
O-540, IO-540 SERIES**

TROUBLE	PROBABLE CAUSE	REMEDY
Failure of Engine to Idle Properly	Incorrect idle mixture	Adjust mixture.
	Leak in induction system	Tighten all connections in the induction system. Replace any parts that are defective.
	Incorrect idle adjustment	Adjust throttle stop to obtain correct idle.
	Uneven cylinder compression	Check condition of piston rings and valve seats.
	Faulty ignition system	Check entire ignition system.
	Insufficient fuel pressure	Adjust fuel pressure.
	Leak in air bleed nozzle balance line	Check connection and replace if necessary.
	Plugged fuel injector nozzle	Clean or replace nozzle.
Low Power and Uneven Running	Flow divider fitting plugged	Clean fitting.
	Mixture too rich; indicated by sluggish engine operation, red exhaust flame at night. Extreme cases indicated by black smoke from exhaust	Readjustment of fuel injector or carburetors by authorized personnel is indicated.
	Mixture too lean; indicated by overheating or backfiring	Check fuel lines for dirt or other restrictions. Readjustment of fuel injector or carburetor by authorized personnel is indicated.
	Leaks in induction system	Tighten all connections. Replace defective parts.
	Defective spark plugs	Clean and gap or replace spark plugs.
	Improper fuel	Fill tank with fuel of recommended grade.
	Magneto breaker points not working properly	Clean points. Check internal timing of magnetos.

TROUBLE	PROBABLE CAUSE	REMEDY
Low Power and Uneven Running (Cont.)	Defective ignition wire	Check wire with electric tester. Replace defective wire.
	Defective spark plug terminal connectors	Replace connectors on spark plug wire.
	Plugged fuel injector nozzle	Clean or replace nozzle.
Failure of Engine to Develop Full Power	Leak in induction system	Tighten all connections and replace defective parts.
	Defective tachometer	Replace tachometer.
	Plugged fuel injector nozzle	Clean or replace nozzle.
	Throttle lever out of adjustment	Adjust throttle lever.
	Improper fuel flow	Check strainer, gage and flow at the fuel line.
	Restriction in air scoop	Examine air scoop and remove restrictions.
	Improper fuel	Drain and refill tank with recommended fuel.
	Faulty ignition	Tighten all connections. Check system with tester. Check ignition timing.
Rough Engine	Cracked engine mount	Replace or repair mounting.
	Defective mounting bushings	Install new mounting bushings.
	Uneven compression	Check compression.
	Plugged fuel injector nozzle	Clean or replace nozzle.
Low Oil Pressure	Insufficient oil	Fill sump to proper level with recommended oil.
	Defective pressure gage	Replace.
	Air lock or dirt in relief valve	Remove and clean oil pressure relief valve.

**SECTION 6
TROUBLE-SHOOTING**

**LYCOMING OPERATOR'S MANUAL
O-540, IO-540 SERIES**

TROUBLE	PROBABLE CAUSE	REMEDY
Low Oil Pressure (Cont.)	Leak in suction line or pressure line	Check gasket between accessory housing and crankcase.
	High oil temperature	See "High Oil Temperature" in "Trouble" column.
	Stoppage in oil pump intake passage	Check line for obstruction. Clean suction strainer.
High Oil Temperature	Insufficient air cooling	Check air inlet and outlet for deformation or obstruction.
	Insufficient oil supply	Fill oil sump to proper level with specified oil.
	Defective temperature gage	Replace gage.
	Low grade of oil	Replace with oil conforming to specifications.
	Clogged oil lines or strainers	Remove and clean oil strainers.
	Excessive blow-by	Usually caused by worn or stuck rings.
	Failing or failed bearing	Examine sump for metal particles. If found, overhaul of engine is indicated.
Excessive Oil Consumption	Low grade of oil	Fill tank with oil conforming to specification.
	Failing or failed bearings	Check sump for metal particles.
	Worn piston rings	Install new rings.
	Incorrect installation of piston rings	Install new rings.
	Failure of rings to seal (new nitrided cylinders)	Use mineral base oil. Climb to cruise altitude at full power and operate at 75% cruise power setting until oil consumption stabilizes.
High Fuel Flow Indication on Fuel Gage	Plugged fuel injector nozzle	Clean or replace nozzle.

LYCOMING OPERATOR'S MANUAL

SECTION 7 INSTALLATION AND STORAGE

	Page
Preparation of Engine for Installation.....	7-1
General.....	7-1
Inspection of Engine Mounting	7-1
Attaching Engine to Mounts	7-1
Oil and Fuel Line Connections	7-1
Propeller Installation.....	7-1
Preparation of Carburetors and Fuel Injectors for Installation	7-2
Carburetor.....	7-2
Fuel Injector	7-2
Corrosion Prevention in Engines Installed in Inactive Aircraft.....	7-2
Installation Drawing.....	7-4

This Page Intentionally Left Blank

SECTION 7

INSTALLATION AND STORAGE

1. PREPARATION OF ENGINE FOR INSTALLATION. Before installing an engine that has been prepared for storage, remove all dehydrator plugs, bags of desiccant and preservative oil from the engine. Preservative oil can be removed by removing the bottom spark plugs and turning the crankshaft three or four revolutions by hand. The preservative oil will then drain through the spark plug holes. Draining will be facilitated if the engine is tilted from side to side during the above operation. Preservative oil which has accumulated in the sump can be drained by removing the oil sump plug. Engines that have been stored in a cold place should be removed to an environment of at least 70°F (21°C) for a period of 24 hours before preservative oil is drained from the cylinders. If this is not possible, heat the cylinders with heat lamps before attempting to drain the engine.

After the oil sump has been drained, the plug should be replaced, safety wired, and the sump refilled with lubricating oil. The crankshaft should again be turned several revolutions to saturate the interior of the engine with the clean oil. When installing spark plugs, make sure that they are clean; if not, wash them in clean petroleum solvent. Of course, there will be a small amount of preservative oil remaining in the engine, but this can cause no harm. However, after twenty-five hours of operation, the lubricating oil should be drained while the engine is hot. This will remove any residual preservative oil that may have been present.

CAUTION

DO NOT ROTATE THE CRANKSHAFT OF AN ENGINE CONTAINING PRESERVATIVE OIL BEFORE REMOVING THE SPARK PLUGS, BECAUSE IF THE CYLINDERS CONTAIN ANY APPRECIABLE AMOUNT OF THE MIXTURE, THE RESULTING ACTION, KNOWN AS HYDRAULICING, WILL CAUSE DAMAGE TO THE ENGINE. ALSO, ANY CONTACT OF THE PRESERVATIVE OIL WITH PAINTED SURFACES SHOULD BE AVOIDED.

General – Should any of the dehydrator plugs, containing crystals of silica-gel or similar material, be broken during their term of storage or upon their removal from the engine, and if any of the contents should fall into the engine, that portion of the engine must be disassembled and thoroughly cleaned before using the engine. The oil strainers should be removed and cleaned in gasoline or some other hydrocarbon solvent. The fuel drain screen located in the fuel inlet of the carburetor or fuel injector should also be removed and cleaned in a hydrocarbon solvent. The operator should also note if any valves are sticking. If they are, this condition can be eliminated by coating the valve stem generously with a mixture of gasoline and lubrication oil.

Inspection of Engine Mounting – If the aircraft is one from which an engine has been removed, make sure that the engine mount is not bent or damaged by distortion or misalignment as this can produce abnormal stresses within the engine.

Attaching Engine to Mounts – See airframe manufacturer's recommendation for method of mounting the engine.

Oil and Fuel Line Connections – The oil and fuel line connections are called out on the accompanying installation drawings.

Propeller Installation – Consult the airframe manufacturer for information relative to propeller installation.

2. PREPARATION OF CARBURETORS AND FUEL INJECTORS FOR INSTALLATION.

Carburetors and fuel injectors that have been prepared for storage should undergo the following procedure before being placed in service.

Carburetor (MA-4-5) – Remove the fuel drain plug and drain preservative oil. Remove the fuel inlet strainer assembly and clean in a hydrocarbon solvent. Reinstall the fuel drain plug and fuel inlet strainer assembly.

Fuel Injector (Bendix) – Remove and clean the fuel inlet strainer assembly and reinstall. Inject clean fuel into the fuel inlet connection with the fuel outlets uncapped until clean fuel flows from the outlets. Do not exceed 15 psi inlet pressure.

CORROSION PREVENTION IN ENGINES INSTALLED IN INACTIVE AIRCRAFT

Corrosion can occur, especially in new or overhauled engines, on cylinder walls of engines that will be inoperative for periods as brief as two days. Therefore, the following preservation procedure is recommended for inactive engines and will be effective in minimizing the corrosion condition for a period up to thirty days.

NOTE

Ground running the engine for brief periods of time is not a substitute for the following procedure; in fact, the practice of ground running will tend to aggravate rather than minimize this corrosion condition.

- a. As soon as possible after the engine is stopped, move the aircraft into the hangar, or other shelter where the preservation process is to be performed.
- b. Remove sufficient cowling to gain access to the spark plugs and remove both spark plugs from each cylinder.
- c. Spray the interior of each cylinder with approximately two (2) ounces of corrosion preventive oil while cranking the engine about five (5) revolutions with the starter. The spray gun nozzle may be placed in either of the spark plug holes.

NOTE

Spraying should be accomplished using an airless spray gun (Spraying Systems Co., "Gunjet" Model 24A-8395 or equivalent). In the event an airless spray gun is not available, personnel should install a moisture trap in the air line of a conventional spray gun and be certain oil is hot at the nozzle before spraying cylinders.

- d. With the crankshaft stationary, again spray each cylinder through the spark plug holes with approximately two ounces of corrosion preventive oil. Assemble spark plugs and do not turn crankshaft after cylinders have been sprayed.

The corrosion preventive oil to be used in the foregoing procedure should conform to specification MIL-L-6529, Type I heated to 200°F/220°F (93°C/104°C) spray nozzle temperature.

NOTE

Oils of the type mentioned are to be used in Lycoming aircraft engines for corrosion prevention only, and not for lubrication. See the latest revision of Lycoming Service Instruction No. 1014 and Service Bulletin No. 318 for recommended lubricating oil.

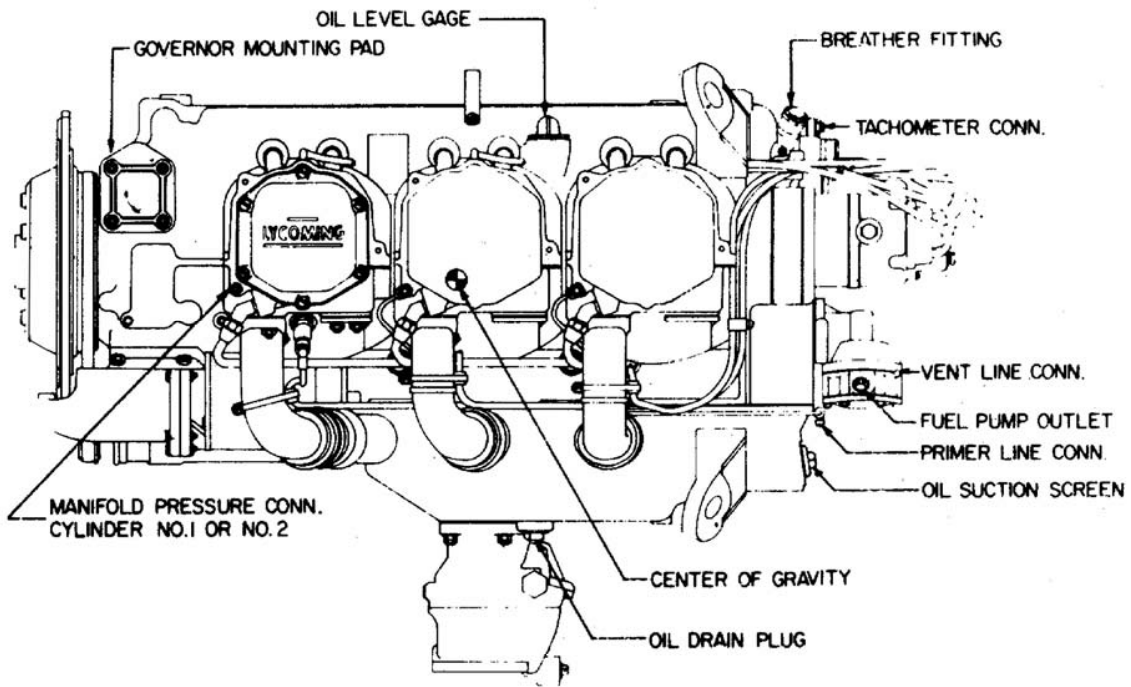

Figure 7-1. Installation Drawing – Left Side View – O-540 Series

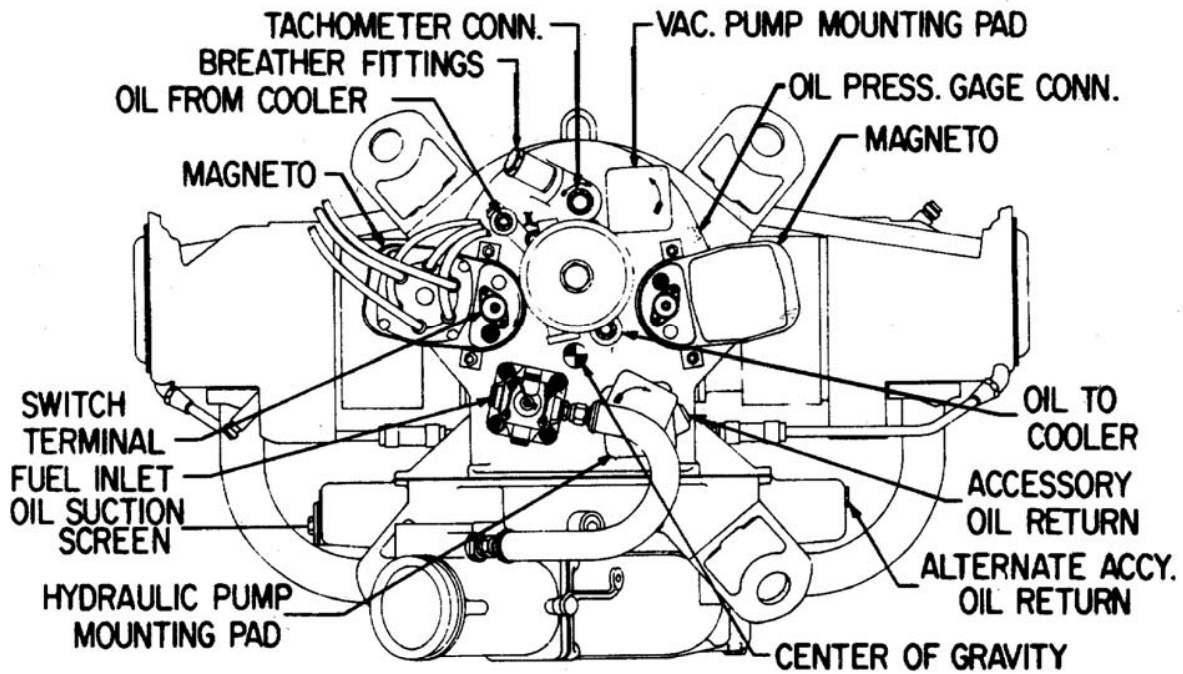

Figure 7-2. Installation Drawing – Rear View – O-540 Series

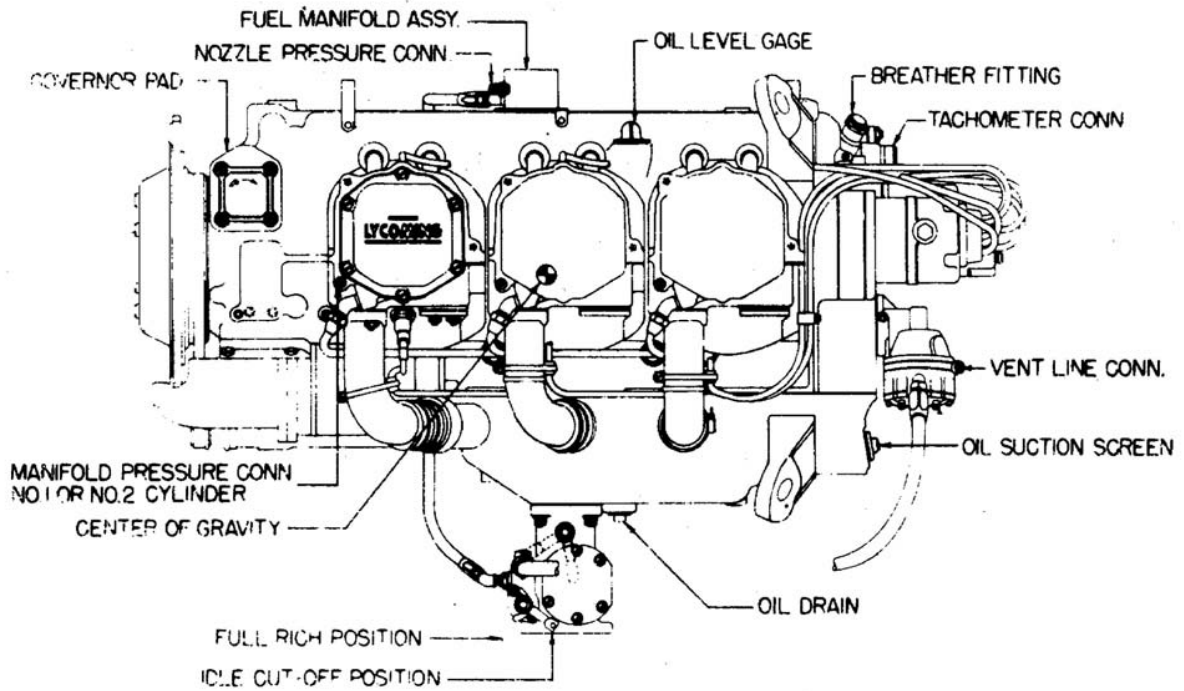

Figure 7-3. Installation Drawing – Left Side View – IO-540-C, -D, -J, -N

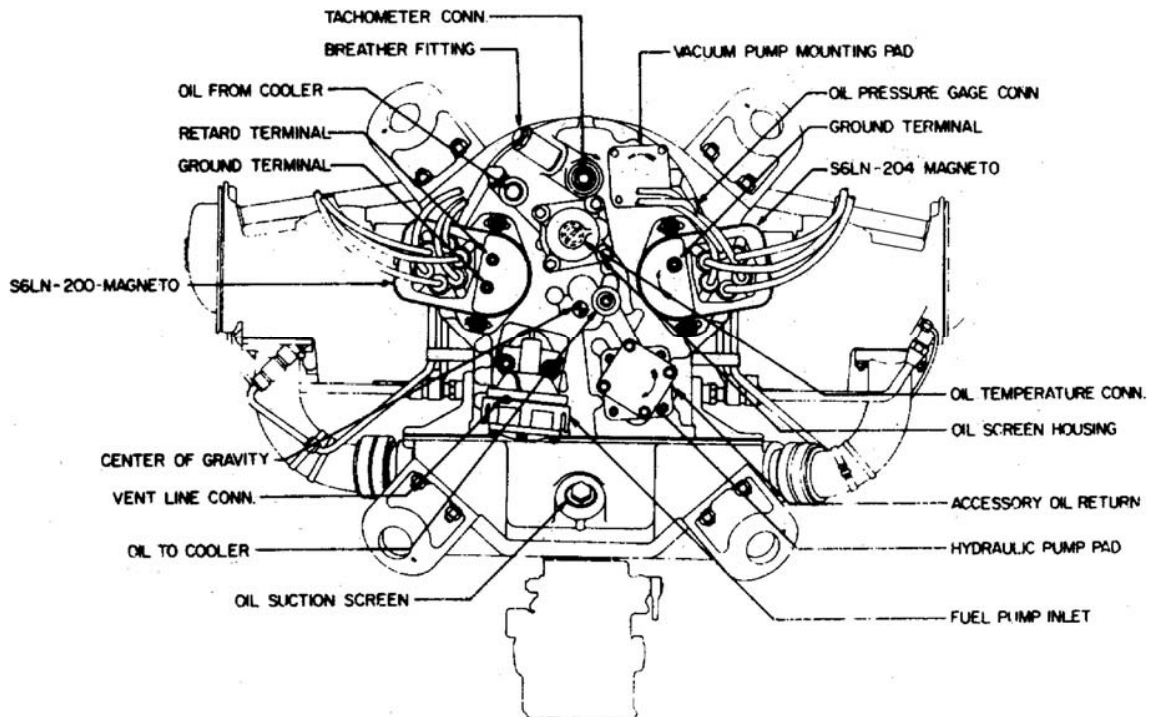

Figure 7-4. Installation Drawing – Rear View – IO-540-C, -D, -J, -N

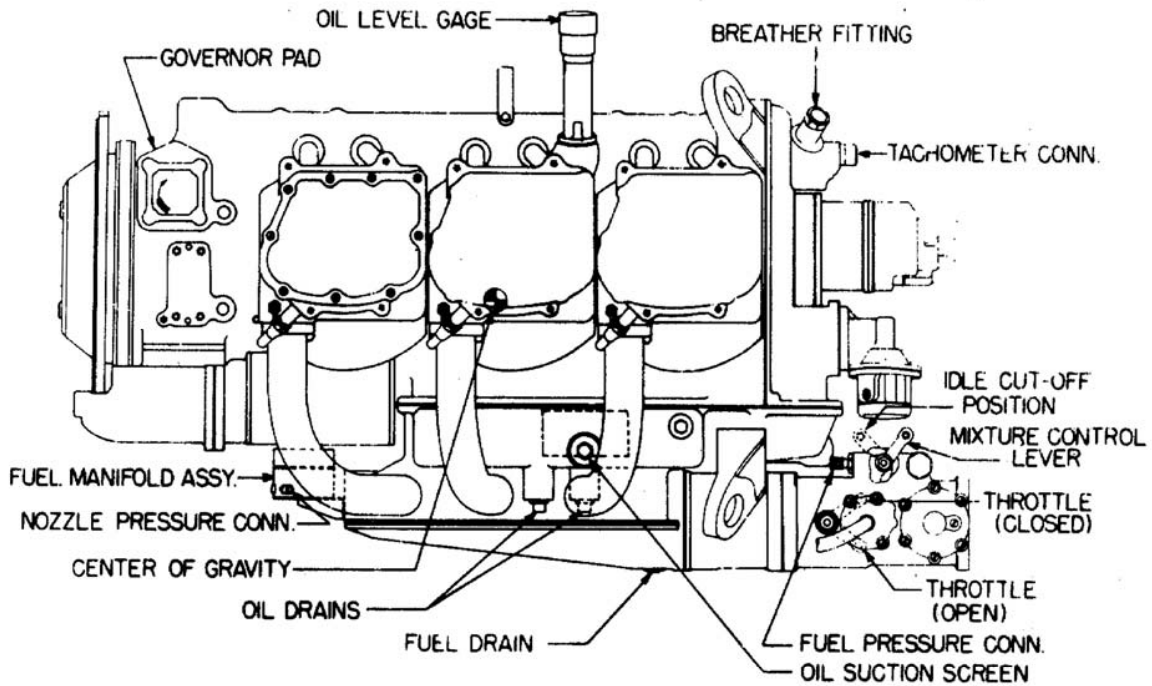

Figure 7-5. Installation Drawing – Left Side View – IO-540-B, -E

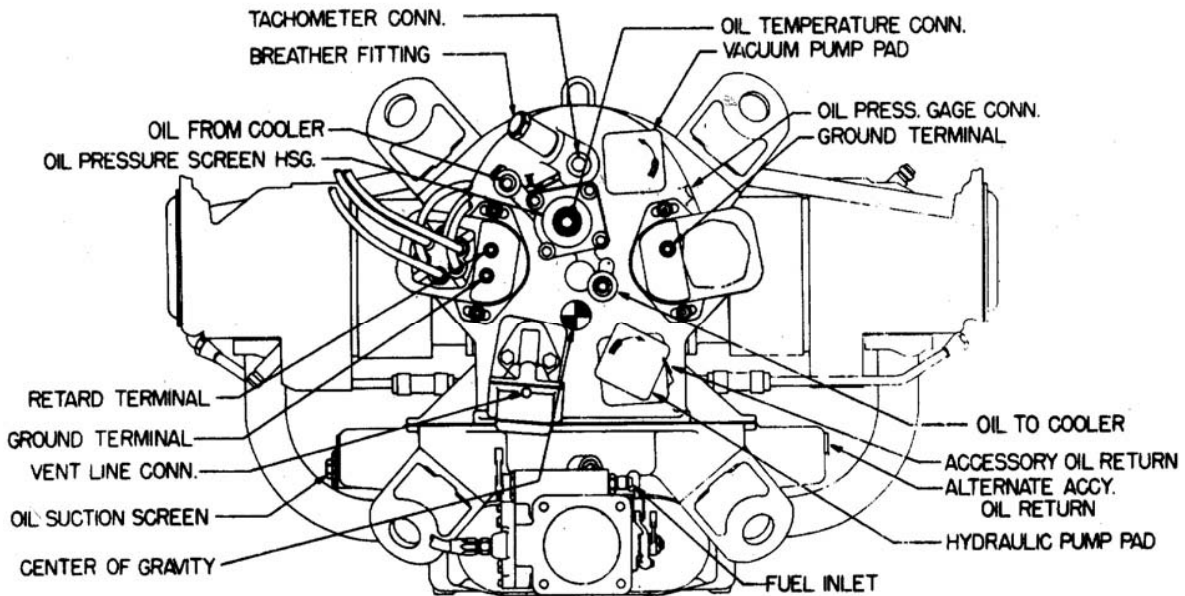

Figure 7-6. Installation Drawing – Rear View – IO-540-B, -E

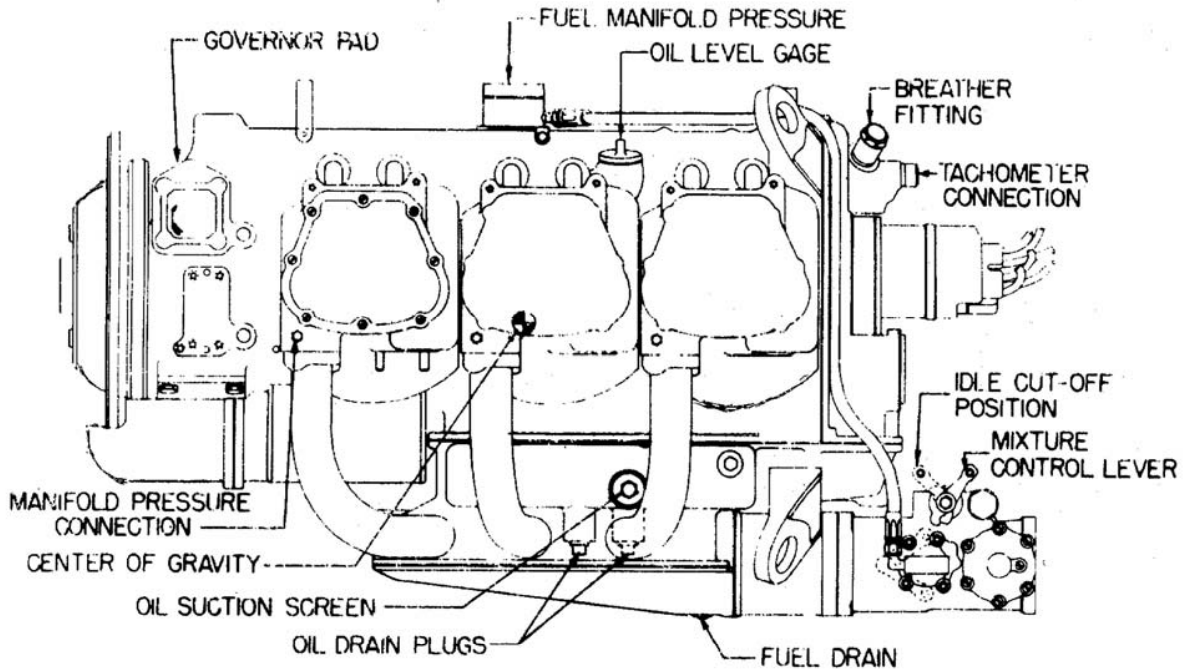

Figure 7-7. Installation Drawing – Left Side View – IO-540-A, -G, -P, -S

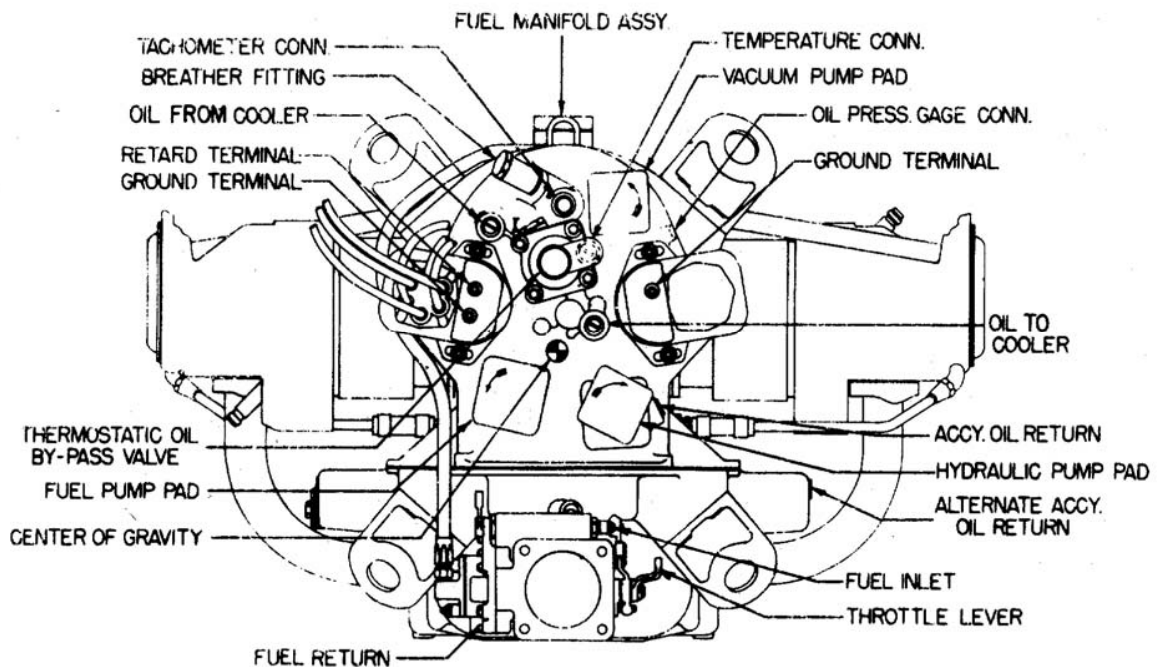

Figure 7-8. Installation Drawing – Rear View – IO-540-A, -G, -P, -S

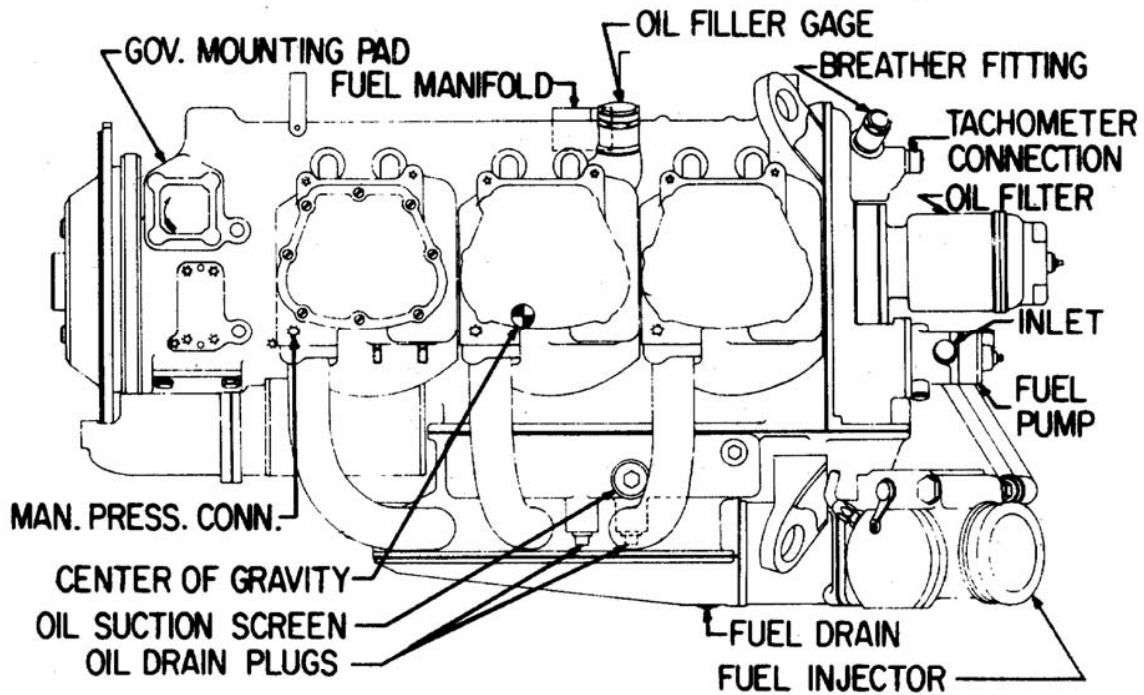

Figure 7-9. Installation Drawing - Left Side View - IO-540-K

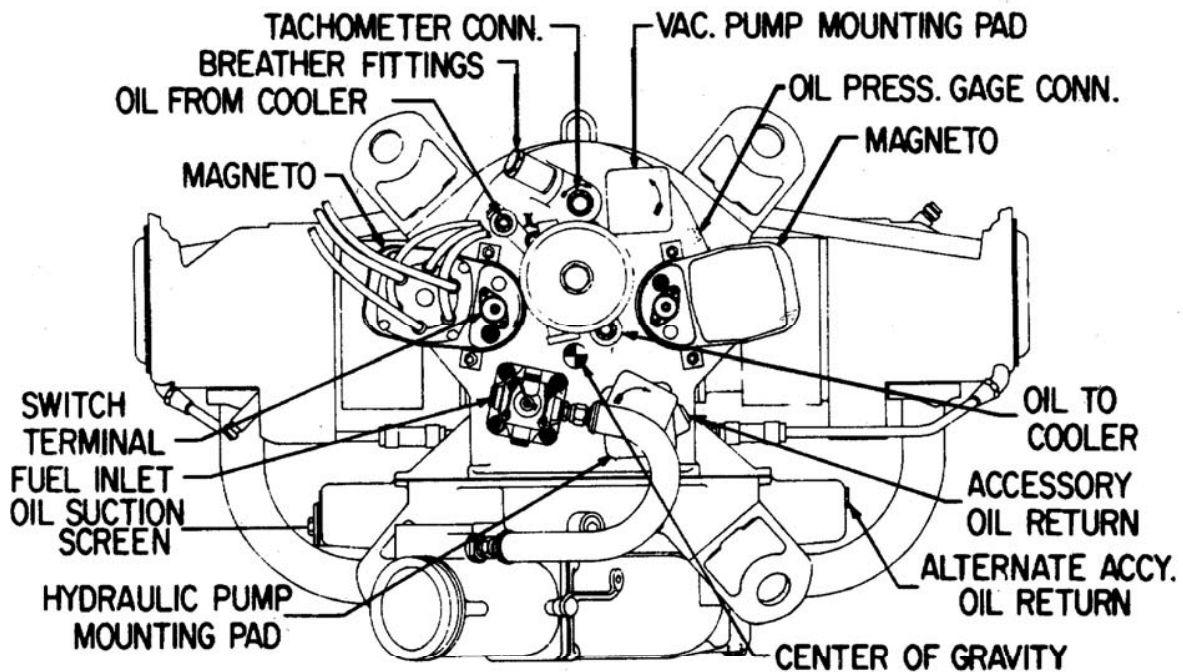

Figure 7-10. Installation Drawing - Rear View - IO-540-K

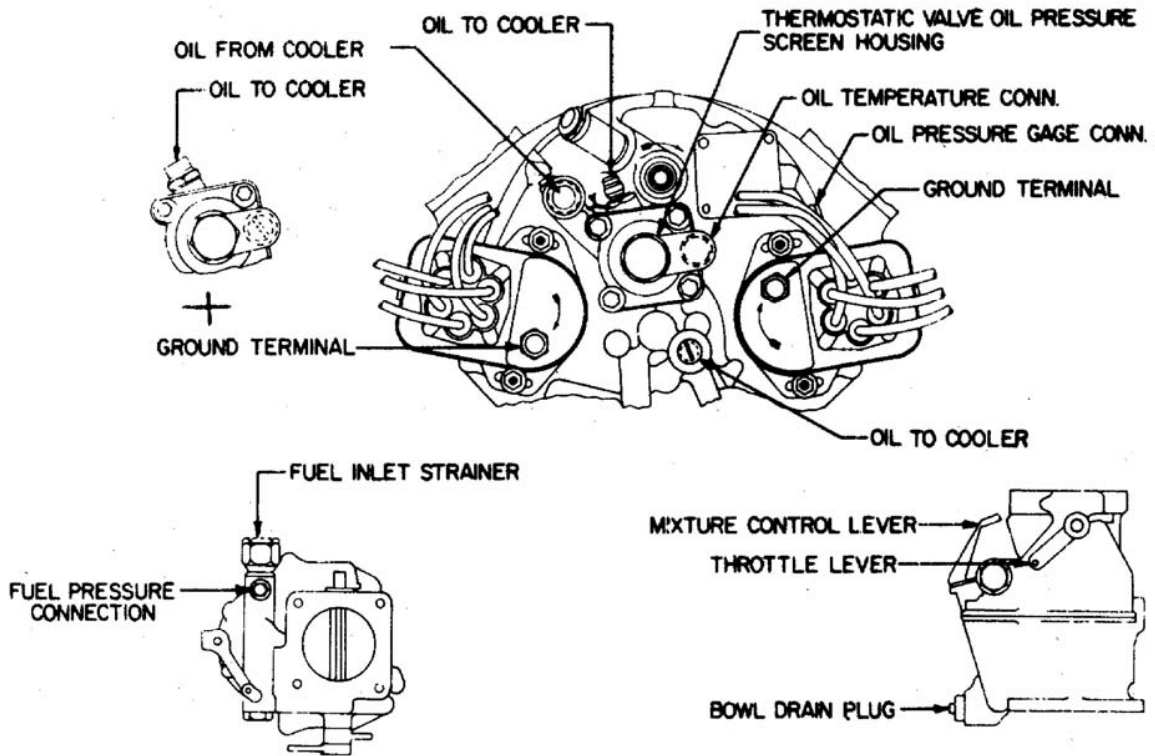

Figure 7-11. Installation Drawing – Alternate Oil Line Connections, Magnetos and View of Carburetor – O-540 Series

This Page Intentionally Left Blank

LYCOMING OPERATOR'S MANUAL

SECTION 8 TABLES

	Page
Table of Limits	8-1
Ground Run After Top Overhaul	8-2
Flight Test After Top Overhaul.....	8-3
Full Throttle HP at Altitude.....	8-4
Table of Speed Equivalents	8-4
Centigrade-Fahrenheit Conversion.....	8-5
Inch – Fraction Conversion	8-6

This Page Intentionally Left Blank

SECTION 8

TABLES

FOR TIGHTENING TORQUE RECOMMENDATIONS AND INFORMATION CONCERNING TOLERANCES AND DIMENSIONS THAT MUST BE MAINTAINED IN LYCOMING AIRCRAFT ENGINES, CONSULT THE LATEST REVISION OF SPECIAL SERVICE PUBLICATION NO. SSP-1776.

CONSULT THE LATEST REVISION OF SERVICE INSTRUCTION NO. 1029 AND NO. 1150 FOR INFORMATION PERTINENT TO CORRECTLY INSTALLING CYLINDER ASSEMBLY.

TEXTRON LYCOMING OPERATOR'S MANUAL

O-540 & IO-540 SERIES

SECTION 8

FIXED WING ONLY

GROUND RUN AFTER TOP OVERHAUL
OR CYLINDER CHANGE WITH NEW RINGS

(DO NOT USE AFTER MAJOR OVERHAUL)

1. Avoid dusty location and loose stones.
2. Head aircraft into wind.
3. All cowling should be in place, cowl flaps open.
4. Accomplish ground run in full flat pitch.
5. Never exceed 200°F. oil temperature.
6. If cylinder head temperatures reach 400°F., shut down and allow engine to cool before continuing.

Type Aircraft _____
 Registration No. _____
 Aircraft No. _____
 Owner _____
 Engine Model _____ S/N _____
 Date _____
 Run-Up By _____

GROUND RUN

Time	RPM	MAP	Temperature				Pressure				Temperature			Fuel Flow			
			L. oil	R. oil	L. cyl	R. cyl	L. oil	R. oil	L. fuel	R. fuel	L. carb	R. carb	Amb. Air	Left	Right		
5 min	1000																
10 min	1200																
10 min	1300																
5 min	1500																
5 min	1600																
5 min	1700																
5 min	1800																

Mag. Check

Power Check

Idle Check

Adjustment Required

After Completion of Ground Run

1. Visually inspect engine(s)
2. Check oil level(s)

TEXTRON LYCOMING OPERATOR'S MANUAL

O-540 & IO-540 SERIES

SECTION 8

FLIGHT TEST AFTER TOP OVERHAUL OR CYLINDER CHANGE WITH NEW RINGS

1. Test fly aircraft one hour.
2. Use standard power for climb, and at least 75% power for cruise.
3. Make climb shallow and at good airspeed for cooling.
4. Record engine instrument readings during climb and cruise.

Tested by _____

FLIGHT TEST RECORD

	RPM	MAP	Temperature				Pressure				Temperature				Fuel Flow		
			L. oil	R. oil	L. cyl	R. cyl	L. oil	R. oil	L. fuel	R. fuel	L. carb	R. carb	Amb. Air	Left	Right		
Time (Climb)																	
Cruise																	

Adjustments Required After Flight

After Test Flight

1. Make careful visual inspection of engine(s).
2. Check oil level(s).
3. If oil consumption is excessive, (see operator's manual for limits), remove spark plugs and check cylinder barrels for scoring.

**FULL THROTTLE HP AT ALTITUDE
(Normally Aspirated Engines)**

Altitude Ft.	% S.L. H.P.	Altitude Ft.	% S.L. H.P.	Altitude Ft.	% S.L. H.P.
0	100	10,000	70.8	19,500	49.1
500	98.5	11,000	68.3	20,000	48.0
1,000	96.8	12,000	65.8	20,500	47.6
2,000	93.6	13,000	63.4	21,000	46.0
2,500	92.0	14,000	61.0	21,500	45.2
3,000	90.5	15,000	58.7	22,000	44.0
4,000	87.5	16,000	56.5	22,500	43.3
5,000	84.6	17,000	54.3	23,000	42.2
6,000	81.7	17,500	53.1	23,500	41.4
7,000	78.9	18,000	52.1	24,000	40.3
8,000	76.2	18,500	51.4	24,500	39.5
9,000	73.5	19,000	50.0	25,000	38.5

TABLE OF SPEED EQUIVALENTS

Sec./Mi.	M.P.H.	Sec./Mi.	M.P.H.	Sec./Mi.	M.P.H.
72.0	50	24.0	150	14.4	250
60.0	60	22.5	160	13.8	260
51.4	70	21.2	170	13.3	270
45.0	80	20.0	180	12.8	280
40.0	90	18.9	190	12.4	290
36.0	100	18.0	200	12.0	300
32.7	110	17.1	210	11.6	310
30.0	120	16.4	220	11.2	320
27.7	130	15.6	230	10.9	330
25.7	140	15.0	240	10.6	340

CENTIGRADE-FAHRENHEIT CONVERSION TABLE

Example: To convert 20°C to Fahrenheit, find 20 in the center column headed (F-C); then read 68.0°F in the column (F) to the right. To convert 20°F to Centigrade; find 20 in the center column and read -6.67°F in the (C) column to the left.

C	F-C	F	C	F-C	F
-56.7	-70	-94.0	104.44	220	428.0
-51.1	-60	-76.0	110.00	230	446.0
-45.6	-50	-58.0	115.56	240	464.0
-40.0	-40	-40.0	121.11	250	482.0
-34.0	-30	-22.0	126.67	260	500.0
-28.9	-20	-4.0	132.22	270	518.0
-23.3	-10	14.0	137.78	280	536.0
-17.8	0	32.0	143.33	290	554.0
-12.22	10	50.0	148.89	300	572.0
-6.67	20	68.0	154.44	310	590.0
-1.11	30	86.0	160.00	320	608.0
4.44	40	104.0	165.56	330	626.0
10.00	50	122.0	171.11	340	644.0
15.56	60	140.0	176.77	350	662.0
21.11	70	158.0	182.22	360	680.0
26.67	80	176.0	187.78	370	698.0
32.22	90	194.0	193.33	380	716.0
37.78	100	212.0	198.89	390	734.0
43.33	110	230.0	204.44	400	752.0
48.89	120	248.0	210.00	410	770.0
54.44	130	266.0	215.56	420	788.0
60.00	140	284.0	221.11	430	806.0
65.56	150	302.0	226.67	440	824.0
71.00	160	320.0	232.22	450	842.0
76.67	170	338.0	237.78	460	860.0
82.22	180	356.0	243.33	470	878.0
87.78	190	374.0	248.89	480	896.0
93.33	200	392.0	254.44	490	914.0
98.89	210	410.0	260.00	500	932.0

**INCH FRACTIONS CONVERSIONS
Decimals, Area of Circles and Millimeters**

Inch Fraction	Decimal Equiv.	Area Sq. In.	MM Equiv.	Inch Fraction	Decimal Equiv.	Area Sq. In.	MM Equiv.
1/64	.0156	.0002	.397	1/2	.5	.1964	12.700
1/32	.0312	.0008	.794	17/32	.5312	.2217	13.494
3/64	.469	.0017	1.191	35/64	.5469	.2349	13.891
1/16	.0625	.0031	1.587	9/16	.5625	.2485	14.288
3/32	.0937	.0069	2.381	19/32	.5937	.2769	15.081
7/64	.1094	.0094	2.778	39/64	.6094	.2916	15.478
1/8	.125	.0123	3.175	5/8	.625	.3068	15.875
5/32	.1562	.0192	3.969	21/32	.6562	.3382	16.669
11/64	.1719	.0232	4.366	43/64	.6719	.3545	17.065
3/16	.1875	.0276	4.762	11/16	.6875	.3712	17.462
7/32	.2187	.0376	5.556	23/32	.7187	.4057	18.256
15/64	.2344	.0431	5.593	47/64	.7344	.4235	18.653
1/4	.25	.0491	6.350	3/4	.75	.4418	19.050
9/32	.2812	.0621	7.144	25/32	.7812	.4794	19.844
19/64	.2969	.0692	7.540	51/64	.7969	.4987	20.241
5/16	.3125	.0727	7.937	13/16	.8125	.5185	20.637
11/32	.3437	.0928	8.731	27/32	.8437	.5591	21.431
23/64	.3594	.1014	9.128	55/64	.8594	.5800	21.828
3/8	.375	.1105	9.525	7/8	.875	.6013	22.225
13/32	.4062	.1296	10.319	29/32	.9062	.6450	23.019
27/64	.4219	.1398	10.716	59/64	.9219	.6675	23.416
7/16	.4375	.1503	11.112	15/16	.9375	.6903	23.812
15/31	.4687	.1725	11.906	31/32	.9687	.7371	24.606
31/64	.4844	.1842	12.303	63/64	.9844	.7610	25.003